

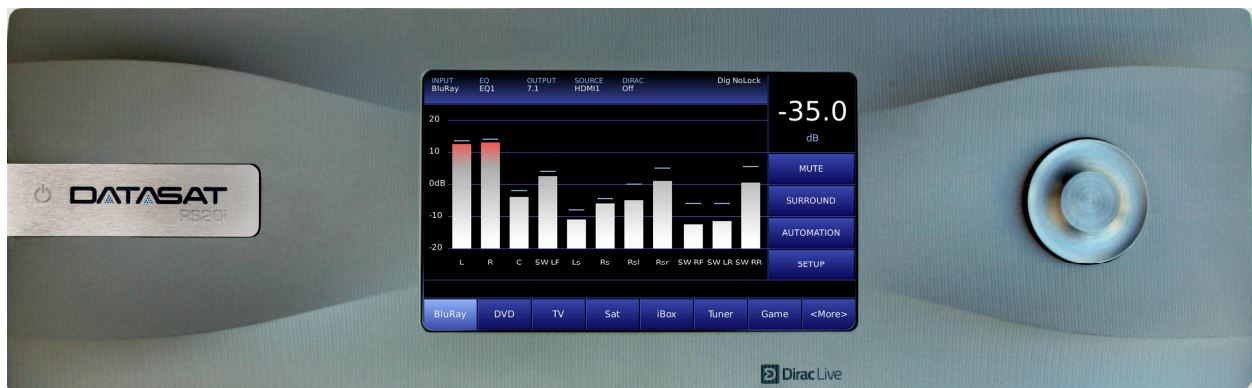

# RS20i Audio Processor

## Installation and Operating Guide



**Version 1.02**

**Effective Date: March 2015  
Document # 9301H52900**

**Datasat Digital Entertainment  
4596 Ish Drive #210  
Simi Valley, CA 93063  
USA**

## Notices

This product contains software proprietary to Datasat Digital Entertainment and protected by US and International copyright law. Unauthorized reproduction or disclosure, in whole or in part, is strictly prohibited.

The software and methods implemented in this product may be protected by one or more of the following patent applications: US Patent Application Nos. 13/077,588 and 61/341,803; and other International patents pending.

### WARRANTY/LIMITATION OF LIABILITY

EXCEPT FOR THE LIMITED WARRANTY PROVIDED HEREIN, THIS PRODUCT IS PROVIDED "AS IS" AND WITHOUT WARRANTY OF ANY KIND. DATASAT DIGITAL ENTERTAINMENT EXPRESSLY DISCLAIMS ALL OTHER WARRANTIES, EXPRESS AND IMPLIED, INCLUDING, BUT NOT LIMITED TO, THE IMPLIED WARRANTIES OF MERCHANTABILITY AND FITNESS FOR A PARTICULAR PURPOSE. DATASAT DIGITAL ENTERTAINMENT DOES NOT WARRANT THAT THIS PRODUCT WILL MEET USER'S REQUIREMENTS, OR THAT THE OPERATION OF THIS PRODUCT WILL BE UNINTERRUPTED OR ERROR-FREE, OR THAT DEFECTS IN THIS PRODUCT WILL BE CORRECTED. UNDER NO CIRCUMSTANCES, INCLUDING NEGLIGENCE, SHALL DATASAT DIGITAL ENTERTAINMENT, OR ITS DIRECTORS, OFFICERS, EMPLOYEES OR AGENTS, BE LIABLE TO USER FOR ANY INCIDENTAL, INDIRECT, SPECIAL OR CONSEQUENTIAL DAMAGES (INCLUDING DAMAGES FOR LOSS OF BUSINESS PROFITS, BUSINESS INTERRUPTION, LOSS OF BUSINESS INFORMATION, AND THE LIKE) ARISING OUT OF THE USE, MISUSE OR INABILITY TO USE THIS PRODUCT OR RELATED DOCUMENTATION.

## Copyright

RS20i Audio Processor Installation and Operating Guide, Version 1.02

© 2012, 2015 Datasat Digital Entertainment. All rights reserved.

The content of this publication is subject to change without notice. Datasat Digital Entertainment assumes no obligation to notify you of any changes or updates. While Datasat Digital Entertainment believes this publication is accurate, due to ongoing improvements and revisions, Datasat Digital Entertainment cannot guarantee the accuracy of printed material, nor can it accept responsibility for errors or omissions. Datasat Digital Entertainment may periodically publish updates and revisions to this publication as it deems necessary.

DTS<sup>®</sup> is a registered trademark of DTS, Inc.

Dolby<sup>®</sup> is a registered trademark of Dolby Laboratories.

Auro-3D<sup>®</sup> is a registered trademark of Auro Technologies.

Dirac Live<sup>®</sup> is a registered trademark of Dirac Research AB protected by Swedish and international trademark laws and treaties.

All other trademarks are the properties of their respective owners.

Manufactured under license from Dolby Laboratories. Dolby and the "double-D" symbol are registered trademarks of Dolby Laboratories.

Manufactured under a license from U.S. Patent No's: 5,956,674 , 5,974,380 , 5,978,762 , 6,487,535 , 6,226,616 , 7,212,872 , 7,003,467 , 7,272,567 , 7,668,723 , 7,392,195 , 7,930,184 , 7,333,929 , 7,548,853 , and 7,283,634. DTS, the Symbol, and DTS and the Symbol together are registered trademarks & DTS Neo:X / 11.1 is a trademark of DTS, Inc. ©2012 DTS, Inc. All Rights Reserved.

Document No. 9301H52900

March 2015

## Record of Changes

Manual Version / Date	Description
1.00 July 2012	Production release.
1.01 December 2012	FCC Class B, UL Class IEC60065
1.02 March 2015	Overall update and addition of Auro-3D functionality

## Regulatory Notices

### INSTRUCTION TO THE USER

This equipment has been tested and found to comply with the limits for a class B digital device, pursuant to part 15 of the FCC Rules. These limits are designed to provide reasonable protection against harmful interference in a residential installation. This equipment generates, uses and can radiate radio frequency energy and if not installed and used in accordance with the instructions, may cause harmful interference to radio communications. However, there is no guarantee that interference will not occur in a particular installation. If this equipment does cause harmful interference to radio or television reception, which can be determined by turning the equipment off and on, the user is encouraged to try to correct the interference by one or more of the following measures:

- \* Reorient or relocate the receiving antenna.
- \* Increase the separation between the equipment and receiver.
- \* Connect the equipment into an outlet on a circuit different from that to which the receiver is connected.
- \* Consult the dealer or an experienced radio/TV technician for help.

In order to maintain compliance with FCC regulations, shielded cables must be used with this equipment. Operation with non-approved equipment or unshielded cables is likely to result in interference to radio and TV reception. The user is cautioned that changes and modifications made to the equipment without the approval of manufacturer could void the user's authority to operate this equipment.

#### *Canadian Department of Communications compliance statement:*

This equipment does not exceed Class B limits per radio noise emissions for digital apparatus set out in the Radio Interference Regulation of the Canadian Department of Communications. Operation in a residential area may cause unacceptable interference to radio and TV reception requiring the owner or operator to take whatever steps are necessary to correct the interference.

#### *Avis de conformite aux normes du ministere des Communications du Canada:*

Cet equipment ne depasse pas les limites de Classe B D'emission de bruits radioelectriques pour les appareils numeriques telles que perscrites par le Reglement sur le brouillage radioelectrique etabli par le ministere des Communications du Canada. L'exploitation faite en milieu residentiel peut entrainer le brouillage des receptions radio et television, ce qui obligerait le proprietaire ou l'operateur a prendre les dispositions necessaires pour en eliminer les causes.

## TABLE OF CONTENTS

Record of Changes .....	3
Regulatory Notices .....	3
Introduction to the RS20i Audio Processor .....	7
How to Use this Guide.....	7
About the RS20i Audio Processor .....	7
Limited Warranty .....	8
Product Improvements and Upgrades.....	8
FACTORY WARRANTY INFORMATION.....	8
Technical Support Contact Information .....	8
Software License Agreement .....	9
1.0 Operating RS20i.....	11
1.1 How-To Procedures – Operations .....	12
1.2 Powering ON the RS20i Processor .....	13
1.3 Operating the Touch Screen .....	14
1.4 The Home Screen .....	14
1.4.1 Adjusting the Volume Control.....	15
1.4.2 Surround Mode.....	15
1.4.3 Manual Automation .....	18
2.0 Installation and Set Up .....	19
2.1 Unpacking System Components .....	19
2.1.1 Important Safety Instructions.....	20
2.2 Installation Overview .....	21
2.3 RS20i Rear Panel Connections.....	22
2.4 Mounting and Connection.....	23
2.4.1 Rack/Enclosure Requirements.....	23
2.4.2 Rack Mount Installation .....	24
2.4.3 Installing/Removing Feet.....	24
2.4.4 Power Supply .....	25
3.0 How-To Procedures for Setup.....	27
3.1 Example: Creating an Input Preset.....	28
4.0 Setup Menus .....	29
4.1 Navigating the Setup Menus .....	29

4.2	Setup Screen .....	35
4.2.1	About Input Presets .....	36
4.2.2	Overview, Creating an Input Preset .....	38
4.3	Input Preset Screen .....	38
4.3.1	Edit Input Presets .....	40
4.3.2	Input Button Assignments .....	42
4.3.3	Enable “More” Button .....	43
4.3.4	Input Source .....	43
4.3.5	Input Options .....	45
4.3.6	Surround Decoder Setup.....	48
4.3.7	Digital Cinema Options.....	52
4.4	Audio EQ Setup.....	53
4.4.1	Edit EQ .....	54
4.4.2	Dirac Live Optimization .....	55
4.4.3	Third Octave EQ.....	56
4.4.4	Parametric Equalization .....	60
4.4.5	Copy/Clear EQ .....	61
4.4.6	Audio Levels.....	62
4.5	Output Preset .....	64
4.5.1	Edit Output Preset .....	66
4.5.2	Channel Names.....	68
4.5.3	Routing/Crossovers .....	69
4.5.4	Channel Delays .....	71
4.5.5	Speaker Filt .....	72
4.6	Bass Management Setup .....	73
4.6.1	Speaker Options Configuration Screen .....	75
4.7	Bass Management Setup Procedure.....	79
4.7.1	Configuration using 1 or more subwoofers.....	80
4.7.2	Configuration with no subwoofers .....	81
4.7.3	Bass Management Theory .....	83
4.8	System Setup .....	86
4.8.1	Update System Software.....	87
4.8.2	USB Save/Restore .....	89
4.8.3	Access Control .....	91
4.8.4	System Info .....	92
4.9	System Setup (2).....	94

4.9.1	Monitor Volume .....	95
4.9.2	Log File.....	97
4.9.3	Date/Time .....	97
4.10	Network Configuration .....	98
4.10.1	Network Diagnostics.....	99
4.10.2	SNMP Agent.....	100
4.11	Automation Macros.....	101
4.11.1	Add Macro .....	102
4.11.2	Copy Macro .....	103
4.12	Automation Edit Action .....	103
4.13	Automation Events .....	105
4.13.1	Add New Event.....	105
4.14	Automation Buttons .....	106
4.15	Automation Serial Setup .....	108
4.16	Automation GPIO Test .....	108
5.0	Maintenance and Troubleshooting.....	110
5.1	Routine Maintenance.....	110
5.2	Troubleshooting.....	110
5.2.1	Over-Temperature Alert .....	111
5.2.2	NoLock .....	111
5.2.3	Volume Control Not Functioning .....	112
5.3	Error Messages .....	112
5.3.1	Software Installation .....	112
5.3.2	Error Booting the RS20i .....	113

**Appendices**

- A. Connector Pin-outs
- B. Interface Wiring Diagrams
- C. Product Specifications
- D. Speaker Configurations
- E. RS20i Remote Control API

## Introduction to the RS20i Audio Processor

This manual explains the RS20i Audio Processor setup and operation. It contains full instructions for installing hardware and software, setting up audio playback, configuring the system, performing maintenance and troubleshooting, and setting up and operating optional functions.

### How to Use this Guide

This guide is divided into three parts. The first part covers functions for the “operator”. The second part covers the installation, setup and other technical functions. The third part consists of appendices with technical details such as connector and wiring diagrams.

**Note:** Technical adjustments should only be performed by a qualified installer. The appendices provide detailed information for the installer.

### About the RS20i Audio Processor

The RS20i audio processor is designed for the high-end consumer audio/home theater market. It has been engineered to deliver precise reproduction of both analog and digital sources, using the power of eight *Analog Devices* 400MHz Digital Signal Processors (DSPs). The standard RS20i offers 16 channels of digital and 8 channels of analog inputs coupled to the 16 digital and 16 analog outputs. In addition to one S/PDIF and two TOSLINK audio inputs, the RS20i features four HDMI 1.4a inputs with Blu-ray HD decoding and active loudspeaker crossovers.

Each of the 16 channels includes:

- 31 bands of 1/3 octave equalization
- 3 bands of parametric equalization
- Channel gain and phase inversion control
- Individual Bass and Treble controls
- Variable delay line adjustable from 0ms to 1000ms

In addition to native support for all common stream types including Dolby TrueHD, DTS-HD Master Audio and DTS Neo:X, the processor has, as an option, the new Auro-3D<sup>®</sup> format bringing fully immersive Surround Sound to a theater audience with speaker configurations up to 13.1.

One of the most compelling features of the RS20i is the inclusion of Dirac Live room optimization technology. Dirac Live is a state-of-the-art digital room correction technology that improves the listener experience by correcting for room modes and anomalies using high-resolution filter technology. Configure once and never touch again. The results are improved musical staging, clarity of dialogue and an enhanced listener experience.

For even greater flexibility, the RS20i Audio Processor has two product expansion slots that are removable from the back of the unit while it is racked. All internal control and data lines are available to expansion cards to service future user needs.

To get the most out of your RS20i, we suggest that you review this manual and keep it available during system installation and initial operation.

## Limited Warranty

Datasat Digital Entertainment software is warranted against defects for a period of 90 days from the date of the original purchase. RS20i hardware is warranted against defects in material and workmanship for a period of three years from the date of the original purchase. This warranty includes parts and labor.

THIS WARRANTY EXCLUDES UNITS THAT HAVE BEEN MODIFIED, REPAIRED BY UNAUTHORIZED PERSONNEL, OR DAMAGED BY ABUSE, IMPROPER OPERATION OR INSTALLATION, DIRT, MOISTURE OR STATIC ELECTRICITY. PROPER OPERATION OF THIS EQUIPMENT REQUIRES THE USE OF A SURGE PROTECTOR AND POWER FILTER. SUPPLYING POWER TO THE RS20i UNIT WITHOUT THE USE OF A PROPERLY FUNCTIONING SURGE PROTECTOR WILL VOID THIS WARRANTY.

Using an uninterruptible power supply (UPS) is highly recommended.

## Product Improvements and Upgrades

Datasat Digital Entertainment reserves the right to make changes and/or improvements to its products, without notification and without incurring any obligation to incorporate such changes or improvements in products previously sold or shipped.

## FACTORY WARRANTY INFORMATION

Products being returned under warranty should be sent to Datasat Digital Entertainment freight prepaid in the original or equivalent packaging. Please contact Datasat Digital Entertainment prior to shipping any parts or merchandise to receive a Return Merchandise Authorization number.

Datasat Digital Entertainment Customer Service

USA +1.818-531-0003  
U.K +44(0) 1189.349.199  
Fax: +1 886 448-6802

Datasat Digital Entertainment's shipping address is:

Datasat Digital Entertainment  
Attn: RMA #  
4596 Ish Drive #210  
Simi Valley, CA 93063  
U.S.A.

Thank you for choosing Datasat Digital Entertainment!

## Technical Support Contact Information

To contact Datasat Digital Entertainment's Technical Support staff:

Telephone: +1.818.401.4253 or toll free in USA and Canada: 1(888) 428-2268

Customer Service: [customerservice@datasat.com](mailto:customerservice@datasat.com)

Technical Support: [techsupport@datasat.com](mailto:techsupport@datasat.com)

Technical Support Europe: [eusupport@datasat.com](mailto:eusupport@datasat.com)



## Software License Agreement

**IMPORTANT: READ THIS SOFTWARE LICENSE ("LICENSE") CAREFULLY BEFORE USING THE DATASAT DIGITAL ENTERTAINMENT SOFTWARE. THE SOFTWARE RESIDING ON THE RS20i AUDIO PROCESSOR AND ANY ACCOMPANYING MATERIALS (COLLECTIVELY, THE "SOFTWARE") ARE LICENSED, NOT SOLD. BY USING THE RS20i AUDIO PROCESSOR, YOU ARE ACCEPTING AND AGREEING TO THE TERMS OF THIS LICENSE. IF YOU DO NOT AGREE TO THE TERMS OF THIS LICENSE, DO NOT USE THE RS20i AUDIO PROCESSOR.**

1. **Grant.** Subject to your compliance with the terms of this License, Datasat Digital Entertainment hereby grants you a non-exclusive, conditional, non-transferable, revocable, limited license to use the Software solely for your own personal private purposes and solely in connection with the RS20i Audio processor. All rights not expressly granted to you are reserved by Datasat Digital Entertainment.
2. **Ownership.** All right, title and interest in and to the Software, all physical copies thereof and all intellectual property embodied therein are and shall remain vested in Datasat Digital Entertainment. You do not own the Software, physical copies thereof or any intellectual property embodied therein.
3. **Restrictions.** You may not (i) copy, distribute, sublicense, lease, transfer or use for external purposes the Software; (ii) reverse engineer, decompile, disassemble, translate, modify, attempt to reveal the source code of the Software, or (iii) create derivative works from the Software.
4. **Termination.** Datasat Digital Entertainment may terminate this license at any time if you violate the terms of this license. Upon termination, you must destroy the Software and related documentation.
5. **LIMITATION ON WARRANTY.** YOU EXPRESSLY ACKNOWLEDGE AND AGREE THAT USE OF DATASAT DIGITAL ENTERTAINMENT SOFTWARE AND HARDWARE IS AT YOUR SOLE RISK. DATASAT DIGITAL ENTERTAINMENT DOES NOT WARRANT THAT THE OPERATION OF THE SOFTWARE OR THE HARDWARE WILL BE UNINTERRUPTED OR ERROR FREE. TO THE MAXIMUM EXTENT PERMITTED BY APPLICABLE LAW, THE DATASAT DIGITAL ENTERTAINMENT SOFTWARE AND HARDWARE ARE PROVIDED "AS IS," WITH ALL FAULTS AND WITHOUT WARRANTY OF ANY KIND, INCLUDING, WITHOUT LIMITATION, THE IMPLIED WARRANTIES OF MERCHANTABILITY, FITNESS FOR A PARTICULAR PURPOSES, AND NON-INFRINGEMENT OF THIRD PARTY RIGHTS, ALL OF WHICH ARE HEREBY EXPRESSLY DISCLAIMED.
6. **LIMITATION OF LIABILITY.** UNDER NO CIRCUMSTANCES, INCLUDING, WITHOUT LIMITATION, NEGLIGENCE, SHALL DATASAT DIGITAL ENTERTAINMENT OR ITS DIRECTORS, OFFICERS, EMPLOYEES OR AGENTS BE LIABLE FOR PERSONAL INJURY, OR ANY INCIDENTAL, SPECIAL, INDIRECT OR CONSEQUENTIAL DAMAGES WHATSOEVER, INCLUDING, WITHOUT LIMITATION, DAMAGES FOR LOSS OF PROFITS, LOSS OF DATA, BUSINESS INTERRUPTION OR ANY OTHER COMMERCIAL DAMAGES OR LOSSES, ARISING OUT OF OR RELATED TO YOUR USE OF THE DATASAT DIGITAL ENTERTAINMENT SOFTWARE OR HARDWARE, HOWEVER CAUSED, REGARDLESS OF THE THEORY OF LIABILITY AND EVEN IF DATASAT DIGITAL ENTERTAINMENT HAS BEEN ADVISED OF THE POSSIBILITY OF SUCH DAMAGES. IN NO EVENT SHALL DATASAT DIGITAL ENTERTAINMENT'S LIABILITY EXCEED THE AMOUNT PAID TO DATASAT DIGITAL ENTERTAINMENT. SOME STATES DO NOT ALLOW THE LIMITATION AND/OR EXCLUSION OF LIABILITY FOR INCIDENTAL OR CONSEQUENTIAL DAMAGES, SO THE ABOVE LIMITATION OR EXCLUSION MAY NOT APPLY TO YOU.
7. **General.** This License will be construed according to the substantive law, but not the choice of law rules, of the State of California and of applicable federal law of the United States. If any dispute arises under this License, the venue for such dispute will be in the California Superior Courts and the Federal District Court for the Central District of California located in Los Angeles, California. In any action brought by either party arising out of this License, the prevailing party

shall be entitled to recover its reasonable attorney's fees and costs. If any provision of this License is held by a court of competent jurisdiction to be unenforceable or if a provision of this License is waived by either party, the remainder of this License shall remain in full force and effect. You may not assign this License without the prior, express written consent of Datasat Digital Entertainment.

## 1.0 Operating RS20i

**Table 1. How-To Procedures – Operations**

Activity	Instructions
Turn Power ON	Press and release the power button on the front panel. If the unit will not power up, be sure that the rear panel power switch is ON and the unit is plugged into a working AC outlet protected by a surge protector. See <i>Powering ON the RS20i Processor</i> , page 13.
Turn Power OFF	Press and hold the power button on the front panel for about 2 seconds.
Adjust volume	Turn the master volume control knob on the front panel to adjust volume on all channels. Turn clockwise to increase volume. See <i>Adjusting the Volume Control</i> , page 15.
Select an input	Touch the desired input in the bottom row of the RS20i display. If you do not see the input you want, see if the right most button displays “More”. If so, tap the More button for more choices. If the desired input is still not shown, the RS20i has not been setup for this input.  See <i>The Home Screen</i> , page 14.
Identify the selected input	The current input is highlighted in the bottom row of the RS20i display. More detail related to this input is shown at the top of the display.
Mute the RS20i	Touch the MUTE button. If successful, the MUTE button is highlighted and the label changes color to red. See <i>Adjusting the Volume Control</i> , page 15.
Unmute the RS20i	Touch the MUTE button. If successful, the button label changes color to white.
Identify muted mode	When the RS20i is muted, the MUTE button label is red.

## 1.1 How-To Procedures – Operations

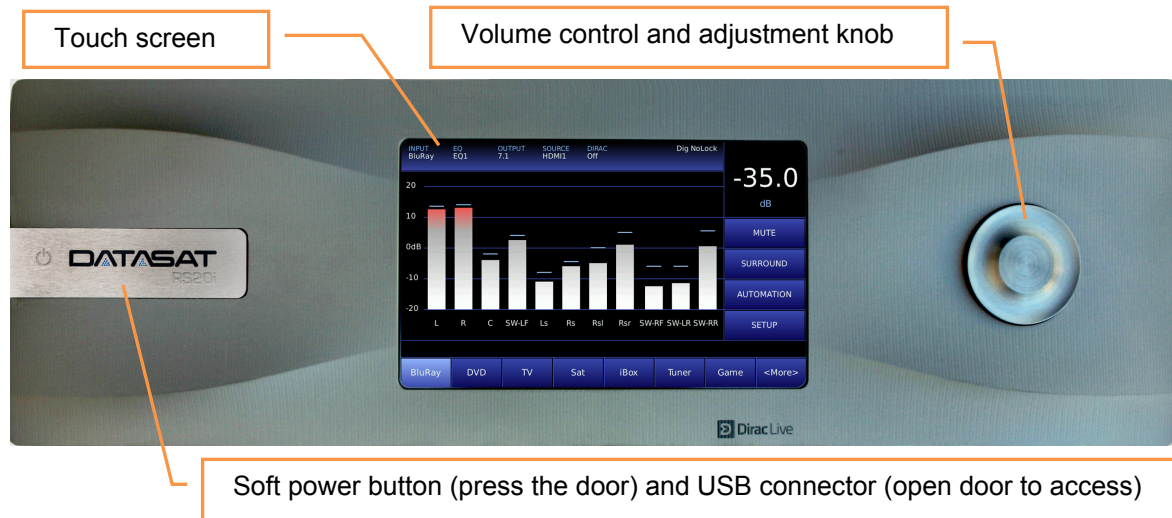

Figure 1. Front Panel Controls and Indicators

The front panel contains the following controls and indicators for operating the RS20i.

**LCD display/Touch Screen:** Displays system configuration and status, and allows configuration changes. Most selections can be made by touching the screen with your finger or by using a soft stylus. The LCD screen operates in two modes:

- **Home screen.** The operator can select Input Presets and mute volume from this screen. You can also change the **surround processing modes** and execute manual **automation commands** via the popup windows. During playback, the screen displays information about the content currently being played.
- **Setup (System) mode.** In setup mode, the screen displays menus for viewing and adjusting operational settings by the installer. The operator does not need to enter these menus.

**Volume Control and adjustment knob:** On the Home screen, this knob adjusts the volume control level. It is used within the setup screens to adjust values, EQ filter, volume controls, and other values. First select the focus by touching the control on the touch screen display. Then move the knob clockwise to increase the value, or counterclockwise to decrease the value.

**Soft Power Button and USB Connector:** Press the power symbol on the door to turn power on/off, and open the door to access the USB connector. Use the USB port for software updates and for loading and saving of configurations. See topics *Update System Software From USB Device* and *USB Save/Restore* on page 88 for more details.



Figure 2: Power Button Door, open position

## 1.2 Powering ON the RS20i Processor



**Warning:** Before powering on the RS20i for the first time, verify that the correct input voltage has been selected at the rear panel power entry module. Incorrect input voltage setting will damage the RS20i. See 2.4.4 *Power Supply*, page 25.

Turn ON the main power switch on the rear panel. A “hard boot” (cycling the power at the power entry module on the rear panel) typically takes the system 75 seconds to initialize. A “soft boot” (pressing the power button on the front panel when power has not been cycled) typically takes about 20 seconds.

While the system is initializing, the following start up screen will appear. As initialization continues, a progress bar will appear and status messages will show in the lower left hand corner of the screen.

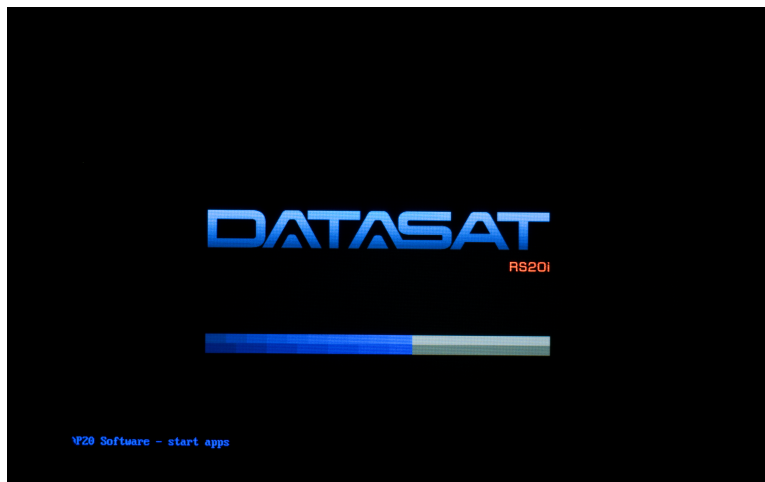

Figure 3. Initial screen

When the Home screen appears, the RS20i is ready.



Figure 4. Home Screen

**Note:** If no image appears on the touch screen after you have turned on the power switch, check the following:

- Is the power to the equipment rack ON? Has the circuit breaker to the audio rack been tripped?
- Is the power cable connected?
- Is the front panel power switch lighted?
- Have the fuses blown? (Note: Confirm that the voltage input setting on the rear panel power entry module has been set correctly for either 115VAC or 230VAC).

### 1.3 Operating the Touch Screen

Since the RS20i is equipped with a touch screen display, you can navigate easily through the menus by touching any button with your finger. A non-abrasive stylus that will not scratch the screen can also be used, if you prefer.

### 1.4 The Home Screen

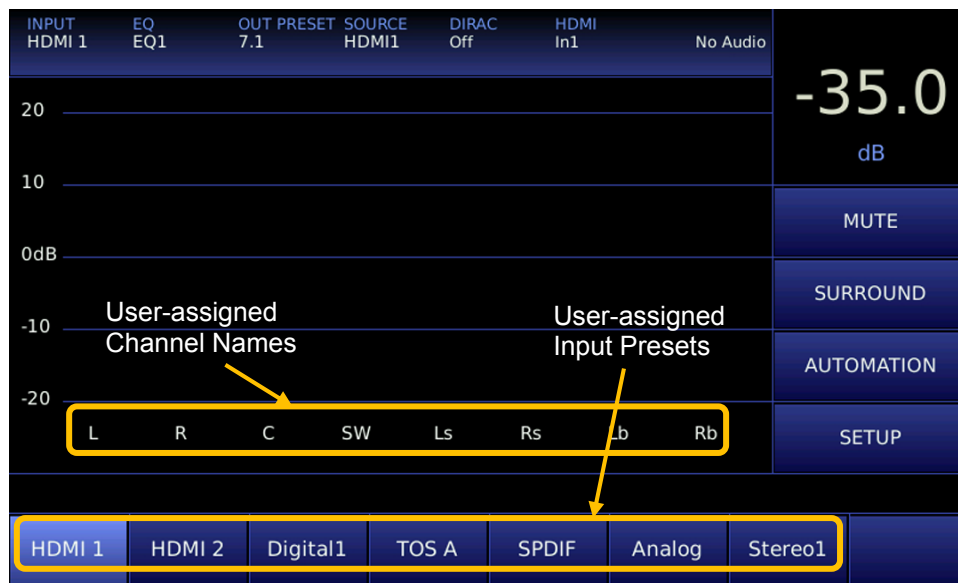

Figure 5. Home Screen

When the system has finished booting up, the Home screen will appear, as shown in the above example. Your Home screen may look somewhat different, due to user-configurable channel names and audio inputs.

The Home screen of the RS20i provides one-touch access to the following features:

- **MUTE:** Master volume mute/unmute
- **SURROUND:** Surround Decoder options
- **AUTOMATION:** Manual control of automation
- **SETUP:** Opens Setup menu (may be password protected)
- Input Preset selections

The Home screen also displays the following information:

- Volume Control level (-70dB to 0 dB)
- Vu bars for all output channels associated with the current audio input.

### 1.4.1 Adjusting the Volume Control

Adjust the volume control by turning the knob on the front panel. A volume level from -70 dB to 0 dB may be selected. The selected volume level is displayed in the upper right corner of the Home screen.

To mute the volume control, touch the **Mute** button. The button label will turn **red**.

Unmute the RS20i by touching the mute button again, changing input level, or changing inputs.



Figure 6 Volume Control and Mute

### 1.4.2 Surround Mode

**Note:** The **SURROUND** function is disabled when the input source is **DIGITAL**.

Select **SURROUND** on the Home screen to open the **Process** screen, where you can choose the surround mode.



Figure 7. Process Screen

Post processor modes include:

- DTS NeoX
- Dolby PLII/Dolby PLIIx
- Dolby PLIIz
- Auro-3D (only available if the Auro-3D option has been purchased)
- None

**Note:** The selection of Post processor modes available will vary depending on the speaker configuration setup in Bass Management.

#### 1.4.2.1 DTS Neo X

DTS Neo:X is available for all speaker configurations except 2.0 and 2.1 Neo:X takes source content from 2 channel, 5.1 or 7.1 content and expand it to 7.1 plus front wide and front high speakers, depending on which speakers are enabled in the RS20i speaker configuration.

These are configuration options for DTS NeoX mode:

- **Cinema** – Neo:X Cinema should be used for a movie presentation.
- **Music** – Neo:X music mode should be used for a music presentation.
- **Game** – Neo:X Game may be used for gaming.

**Option: Make sub from 2ch content:** Extract SW Off/On – If set ON, when the unit receives 2-channel source content a subwoofer channel will be created from the low frequencies of the content. If set OFF, there will be no subwoofer output with 2-channel source content.

#### 1.4.2.2 Dolby PLIIz

Dolby PLIIz is available for speaker configurations that include HL/HR speakers. It is used to expand 2-channel, 5.1, or 7.1 up to 9 available speakers in the speaker configuration LCR, Ls/Rs, Lb/Rb and HL/HR. When PLIIz is selected, there is no output on HLs/HRs and HC/T.

These are configuration options for Dolby PLIIz mode:

**Height Gain:** Low, Mid, or High – This determines how much of the audio gets pushed up to the higher speakers (measured in dB). When set to **high**, more sound will come from the Left High and Right High speakers (HL/HR).

#### 1.4.2.3 Dolby PLII

Dolby PLII is available only when the speaker configuration does not include the back surround channels (BL/BR). It is used to expand 2-channel to fill up to 5.1 speaker configurations.

These are configuration options for Dolby PLII mode:

##### **Dolby Pro Logic**

##### **Music**

- Panorama On or Off – create a seamless wraparound surround effect.
- Center Width – from 0 (off) to 7 (Phantom). This controls the balance of the main vocals in the center and front channels for more natural sound.
- Dimension – adjusts the balance of the surround sound from +7 (Full to Surround) to -7 (Full to Front).

**Movie** – optimized for movie presentation.



#### 1.4.2.4 Dolby PLIIx

These are configuration options for Dolby PLIIx mode:

##### **Music**

###### PLIIx Music Options

- Panorama On or Off – create a seamless wraparound surround effect.
- Center Width – from 0 (off) to 7 (Phantom). This controls the balance of the main vocals in the center and front channels for more natural sound.
- Dimension – adjusts the balance of the surround sound from +7 (Full to Surround) to -7 (Full to Front).

**Movie** – surround mode optimized for movie presentation.

**Dolby D EX** – For Dolby Digital EX content use the Dolby Digital EX decoder to produce a back surround channel.

#### 1.4.2.5 Auro-3D

Select **Auro-3D** in the Process screen to create an immersive sound experience using one of the Auro Speaker configurations. When selected, the Auro processing works in one of two ways. Auro-encoded input signals, natively recorded and/or mixed for an Auro-3D configuration, are decoded with the built-in Auro-Codec<sup>®</sup> Decoder. Alternatively, legacy content (standard stereo, surround and mono sources) may be up-mixed using the Auro-Matic<sup>®</sup> upmixer module.

These are configuration options for Auro-3D mode:

**Preset** – These are Auro-Matic<sup>®</sup> upmixer options to adjust the 3D effect for different content or preferences.

- Preset Small
- Preset Medium
- Preset Large
- Preset Speech

**Strength:** 1 to 16 – Adjusts the strength of the Auro-Matic<sup>®</sup> upmixer where 16 is the highest amount of upmixing.

##### **Auro-3D Listening Mode:**

- Stereo – Plays in stereo (Left Front/Right Front)
- Surround – Does not use High channels. Plays in 5.1 or 7.1 configurations, depending on whether back surrounds are included in the speaker configuration.
- Auro-3D – Full 3D audio experience. Auro content is decoded to its original speaker configuration. Non-Auro content is upmixed to the RS20i Speaker Configuration.
- Native – Decodes Auro-3D native content but does not upmix non-Auro-3D content.

### 1.4.3 Manual Automation

The **Automation** button opens the automation manual control screen.

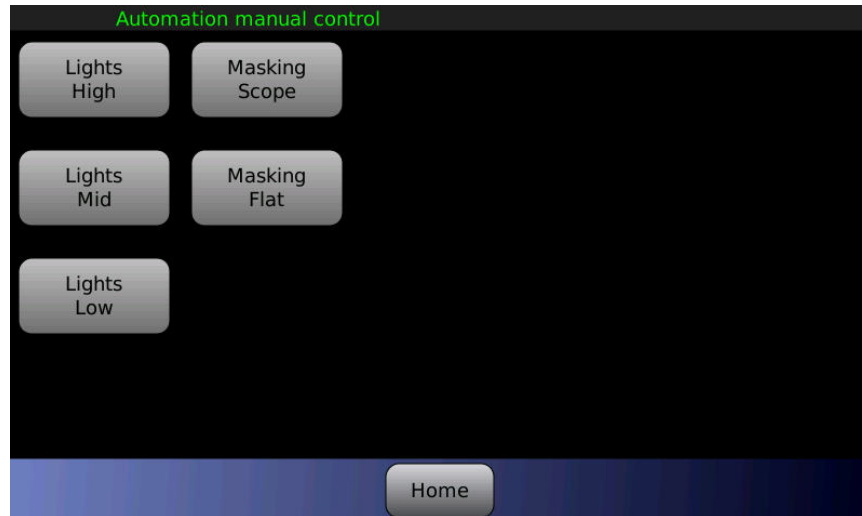

Figure 8. Automation Manual Control screen, example

This screen allows for direct control of automation events in any order, at any time. The installer creates the automation buttons with custom functionality through the automation setup menus. A maximum of twenty buttons can be assigned. If no buttons are displayed, then there were no automation buttons defined in the current setup.

For details about configuring Automation Buttons and the associated Macro functions, see 4.11 *Automation Macros*, page 101, and 4.14 *Automation Buttons*, page 106.

## 2.0 Installation and Set Up

This part of the manual contains information the installer needs to set up and configure the RS20i Audio Processor. Refer to the Important Safety Instructions, page 20.

### 2.1 Unpacking System Components

The packaging is designed to handle normal shipping and handling. Upon receipt of shipment, check for signs of damage before opening and report all damage to the carrier. All shipments made from Datasat Digital Entertainment are the customer's responsibility once they leave our premises.

Before installation begins, we suggest that a complete inventory be taken to minimize problems or questions during installation.

**Important:** Save all packing material. A unit that is returned to the factory must be in its original packing to provide effective protection to the unit. Failure to do so may void your warranty.

**Note:** Refer to the actual packing slip from your order to verify the contents of your shipment. Contact Datasat Digital Entertainment immediately if items listed on your packing slip are missing.

The following is a standard packing list for the RS20i Audio Processor. The exact contents may vary, depending on the options you have ordered.

**Table 2. RS20i Standard Packing Kit**

Item Key	Item Description	Qty
2501000100	Power cord, North American/Taiwan (Note: International power cords may also be included, as needed)	1
9003E11901	Rack screw kit, Truss head screw & washer	1
9003H56400	Fuse kit, RS20i 115V	1
9003H56401	Fuse kit, RS20i 230V	1
9120H56000	Rack ear, RS20i	2
9022H51901	Cable assembly, DB25 to XLR Analog Audio Output	2
9303H561M0	Tech note, RS20i Input voltage setting and fuse replacement	1
9331H71600	RS20i Document disc (includes Installation/Operation manual and other documents)	1

## 2.1.1 Important Safety Instructions

- Read and retain these instructions.
- Follow all instructions.
- Heed all warnings.
- Do not use this apparatus near water.
- Clean only with dry cloth.
- Do not block any ventilation openings. Install in accordance with the manufacturer's instructions.
- Do not install near any heat sources such as radiators, heat registers, stoves, or other apparatus (including amplifiers) that produce heat.
- Do not defeat the safety purpose of the polarized or grounding-type plug. A polarized plug has two blades with one wider than the other. A grounding type plug has two blades and a third grounding prong. The wide blade or the third prong are provided for your safety. If the provided plug does not fit into your outlet, consult an electrician for replacement of the obsolete outlet.
- Protect the power cord from being walked on or pinched particularly at plugs, convenience receptacles, and the point where it exits from the apparatus.
- Only use attachments/accessories specified by the manufacturer.
- Use only with the cart, stand, tripod, bracket, or table specified by the manufacturer, or sold with the apparatus. When a cart is used, use caution when moving the cart and apparatus combination to avoid injury from tip-over.
- Unplug this apparatus during lightning storms or when unused for long periods of time.
- Refer all servicing to qualified service personnel. Servicing is required when the apparatus has been damaged in any way, such as the power-supply cord or plug is damaged, liquid has been spilled or objects have fallen into the apparatus, the apparatus has been exposed to rain or moisture, and does not operate normally, or has been dropped.

Portable Cart Warning



### Warning and Caution Notices



**WARNING:** Before powering on the RS20i for the first time, verify that the correct input voltage has been selected at the rear panel power entry module. An incorrect input voltage setting will damage the RS20i. See 2.4.4 *Power Supply*, page 25.



**Power Cord to the RS20i rear panel:** The power cord is the main disconnect device. It should be plugged into an easily accessible outlet with surge protection. The power cord to be used is a minimum type SVT 18/3 rated 250 Volts AC, 10 Amps with a maximum length of 4.5 M, with one end terminated in an IEC 320 attachment plug and the other end terminated in a NEMA 5-15P Plug.



**WARNING:** To reduce the risk of fire or electric shock, do not expose this apparatus to rain or moisture. Do not expose this apparatus to dripping or splashing. No objects filled with liquids, such as vases, shall be placed on the apparatus.



**WARNING:** This apparatus is a Class I product. This product must be connected to a mains socket outlet with a protective earthing connection.



Only use at altitude not exceeding 2000m. This requirement is for China only under China national differences GB 8898-2011.

## 2.2 Installation Overview

Installation procedures include:

- Checking the RS20i for proper input voltage setting/fuses
- Mounting the RS20i chassis in a rack (if rack mount installation is desired)
- Connecting the RS20i unit to other equipment



**DEVICE DISCONNECT:** The power outlet shall be installed near the equipment and shall be easily accessible, in order to quickly disconnect power.

### 2.3 RS20i Rear Panel Connections

Figure 9 shows the rear panel of the RS20i and Table 3 provides a description of each connector. For specific information on the pin-outs of each connector, please see Appendix A of this manual.

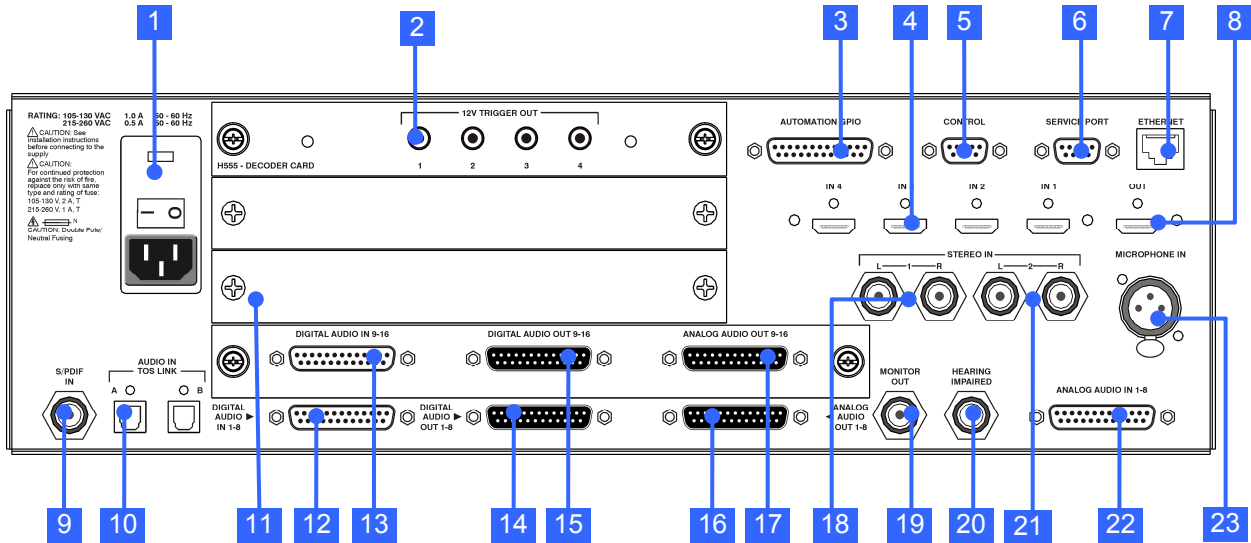

Figure 9. RS20i Rear Panel

Table 3. RS20i Rear Panel Connections

Item	Description	Item	Description
1	Power Entry Module/Power Switch	12	Digital Audio In (CH 1 – 8) – DB25F
2	12 volt trigger out (4) – 3.5mm mono jacks. Used for automation functions such as powering on amplifiers.	13	Digital Audio In (CH 9 – 16) – DB25F
3	Automation GPIO – DB25F (sends/receives pulses to/from automation system or other devices)	14	Digital Audio Out (CH 1 – 8) – DB25M (for use in environments with amplifiers, routers, or crossovers that can handle digital in)
4	HDMI In (4)	15	Digital Audio Out (CH 9 – 16) – DB25M (for use in environments with amplifiers, routers, or crossovers that can handle digital in – see Digital Out Setup, page 86, to configure)
5	Control (RS232) – DB9F (serial automation control)	16	Analog Audio Out (CH 1 – 8) – DB25M (connect to amplifiers)
6	Service Port (RS232)– DB9F (used for factory testing)	17	Analog Audio Out (CH 9 – 16) – DB25M (connect to amplifiers)
7	Ethernet – RJ45F (Network connection for VNC and software updates when connected to the internet)	18	Stereo Input 1 – Two RCA L/R Single ended analog inputs

Item	Description	Item	Description
8	HDMI Out (1)	19	Monitor Out – RCA (connect to externally-powered amplified speaker)
9	S/PDIF In - RCA Female 75 Ohm digital interface (connect a DVD player, game player, or other devices typically found in a home theater environment)	20	Hearing Impaired Audio Out – RCA
10	Audio In (2) – Optical TOS Links (connect a DVD player , game player, or other devices typically found in a home theater environment)	21	Stereo Input 2 – RCA same as 18
11	Option (expansion) Card Slots (2)	22	Analog Audio In – DB25F
		23	Microphone In – XLR F (connect microphone to use as a public address or to perform room EQ adjustments using RTA feature)

## 2.4 Mounting and Connection

The RS20i may be mounted in a standard equipment rack or placed on a cabinet.



**WARNING:** Before powering on the RS20i for the first time, verify that the correct input voltage has been selected at the rear panel power entry module. Incorrect input voltage setting will damage the RS20i. See section 2.4.4.



**CAUTION:** Because power line surges can damage the RS20i, we require the use of a properly functioning computer-grade surge /spike suppressor. We also recommend using an uninterruptible power supply (UPS) with minimum 200 VA.

1. Install rack ears (if rack mounting) on the RS20i. These are included in the RS20i packing kit.
2. Install the RS20i into the audio rack, or place on a cabinet.
3. Connect the RS20i to other equipment. (See Appendix A *Connector Pin-outs* and B *Interface Wiring Diagrams*.)
4. Connect the supplied power cable between the RS20i unit and the AC mains source.

### 2.4.1 Rack/Enclosure Requirements

Follow these recommendations if the RS20i unit will be installed in a closed or multi-unit rack/enclosure assembly.

- Elevated Operating Ambient Temperature – Determine the operating ambient temperature within the rack or enclosure, since this may be greater than the ambient temperature in the room. The maximum ambient temperature for the equipment in a closed or multi-rack assembly is 40°C (104F°).
- Reduced Air Flow – Ensure adequate airflow for cooling purposes on all sides of the equipment. Make sure that the ventilation fan is not blocked.
- Mechanical Loading – Mounting of the equipment in a rack should be such that a hazardous condition is not caused due to uneven mechanical loading.

- **Circuit Overloading** – Consideration should be given to the connection of the equipment to the supply circuit and the effect that overloading of the circuits might have on over-current protection and supply wiring. Appropriate consideration of equipment nameplate ratings should be used when addressing this concern.
- **Reliable Earthing** – Maintain reliable grounding of the equipment. Give particular attention to supply connections when connecting to power strips, rather than direct connections to the branch circuit.
- **Surge Protection** – Using a properly functioning quality surge protector is required to protect the unit. Using an uninterruptible power supply is also recommended.

## 2.4.2 Rack Mount Installation

The RS20i requires 3U of standard rack space for proper mounting.

**Note: The RS20i ships with feet installed. Remove these if necessary for rack space clearance**

Install the rack ears onto the RS20i by removing three 8-32 screws on each side of the RS20i and using them to attach the rack ears.



Figure 10. Rack Ear Installation

Mount the RS20i into the rack securing it properly with 4 rack screws. 10-32 Rack screws and washers are provided in the packing kit.

## 2.4.3 Installing/Removing Feet

The RS20i is shipped with feet already installed, for placing on a desktop or shelf. When rack mounting, the feet may need to be removed for clearance. To remove the feet, simply twist by hand counter-clockwise.

To replace feet, screw them onto the bottom of the RS20i and hand-tighten.



**WARNING:** Use only the feet provided with the RS20i, which have the correct screw length to prevent internal damage to the RS20i circuitry.



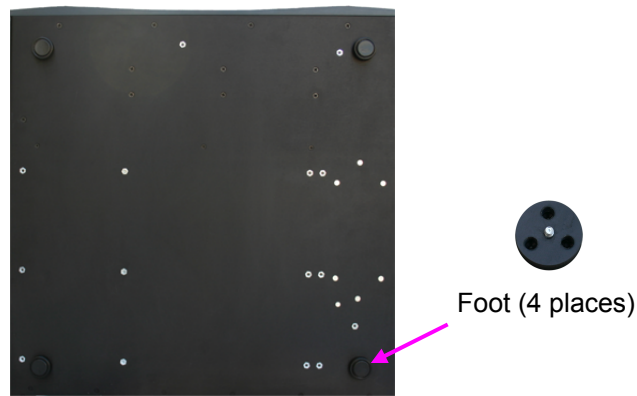



Figure 11. RS20i Feet

## 2.4.4 Power Supply

 **WARNING:** Before powering on the RS20i for the first time, verify that the correct input voltage has been selected at the rear panel power entry module. Incorrect input voltage setting will damage the RS20i.

The RS20i may be set for either 115V (105-130V operation) or 230V (215-260V operation).

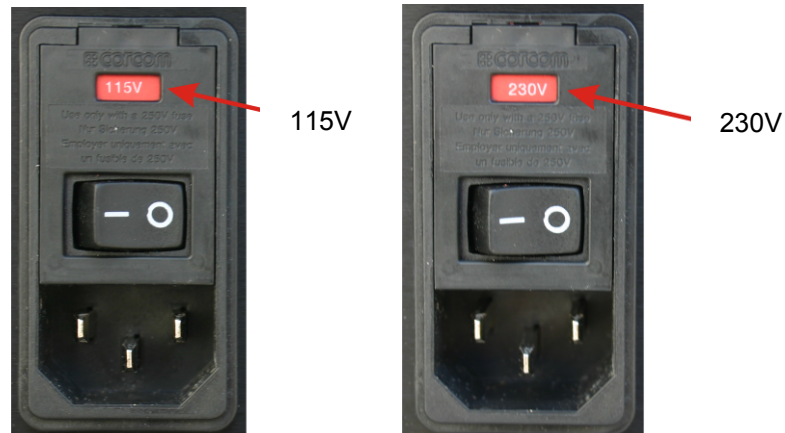

Figure 12. Power Entry Module – Voltage Input Settings

### 2.4.4.1 Changing the Input Voltage Setting and Fuses

 **CAUTION:** DOUBLE POLE/NEUTRAL FUSING

Open the fuse compartment door. A small flat blade screwdriver may be used to release the door. Protect the RS20i metal finish, from damage by the screwdriver, with a rag or other soft material.

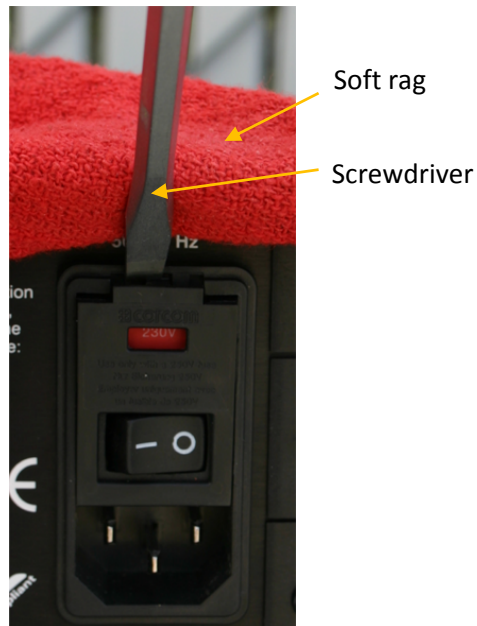

Figure 13. Power Entry Module – Releasing the Fuse Compartment Door

Remove the fuse block by freeing it with a small flat blade screwdriver. The block has slots for this purpose in the top and bottom. Do not try to pry the block out from the sides, as this will damage the block. Use a rag or other soft material to protect the RS20i metal finish.

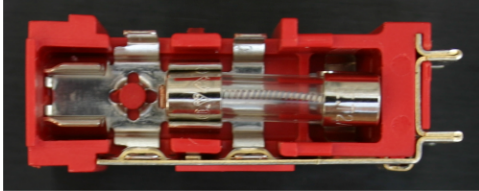

Figure 14. Accessing Fuse Block. Pry from top or bottom only.

Remove the fuse block and install correct fuses. The RS20i uses two 5x20 mm fuses (one on each side of the fuse block):

- For 115V operation, use two 2A, T fuses.
- For 230V operation, use two 1A, T fuses.

Insert the fuses into the fuse block, as shown in Figure 15 below.



Note: When 5x20mm fuse is used, make sure it is inserted at the “live” end of the fuse block, as shown.

Figure 15. Fuse Correctly Positioned in Fuse Block

Replace the fuse block in the power entry module and verify that the correct voltage setting is shown (see Figure 12).

### 3.0 How-To Procedures for Setup

This table provides a list of setup activities and provides instructions or a link to instructions elsewhere in this manual.

**Table 4. Setup Procedures**

Activity	Instructions
Assign an Input button	See 4.3.2 <i>Input Button Assignments</i> , page 42.
Unassign / delete an Input button	See 4.3.2 <i>Input Button Assignments</i> , page 42 – select the button and assign a “blank” input to it.
Configure power-on Input (Startup Input)	See <i>Startup Preset Input</i> , page 40.
Create an Input	See 3.1 <i>Example: Creating an Input</i> , below. For detailed information about Inputs, see □4.2.1 <i>About Input Presets</i> , page 36.
Assign Channel Names and Vu meters	See 4.5.2 <i>Channel Names</i> , page 68.
USB Save / Restore / Load	See 4.8.2 <i>USB Save/Restore</i> , page 89.
Load a personalized screen saver	To set screensaver time and mode, see 4.8 <i>System Setup</i> , page 86.
Set up Global Audio Delay for an input	See 4.3.5.1 <i>Global Delay and Surround Offset</i> , page 46.
Set up Digital Cinema option	For digital cinema input, see 4.3.7 <i>Digital Cinema Options</i> , page 52
View RS20i System information	See 4.8.4 <i>System Info</i> , page 92.
Update RS20i software	See 4.8.1 <i>Update System Software</i> , page 87.

### 3.1 Example: Creating an Input Preset

Once the RS20i is installed, you need to make sure that Input Presets have been assigned for each of the input sources required by your system. The RS20i ships with a set of pre-built Input Presets that are ready to use. To create user-defined Input Presets for other input sources required by your system, use the RS20i setup menus. This section gives a brief introductory example of how to create an Input Preset. Detailed explanation of the Input Preset as well as all RS20i configuration items is given in the next section, about Setup Menus.

Prior to creating an input, it is necessary to identify the following:

- Input source
- Input options
- EQ set up - Name
- Output preset - Name

The following example describes how to create “stereo 2” input, with stereo input, stereo level gain of 1.0 dB, global delay of 0 ms, assignment of EQ and output preset.

1. Open the Input Setup screen by selecting “Inputs”.

#### Setup > Inputs

2. Next select **Edit Input Presets**. The Edit Input Presets screen displays.
3. On the left side choose the Copy Input Preset radio button.
4. Under Copy, select Stereo1.
5. Touch the blank box under **to**. A keyboard will appear.  
Type in *Stereo2*, then select **OK**. The Edit Input Presets screen will return.
6. Touch the **Copy** button.

The screen will now change to Input Setup.

7. Select **Assign Buttons** and the Input Button Assignments screen will display. Select an unused button number from the **Buttons** drop down menu. In this example select button 3.
8. Next from the **Assign** drop down list, select **Stereo 2**. Then touch the **Assign** button on the right side of the screen. In the Current Assignments listing on the screen, Button 3 will now be assigned to **Stereo 2**.
9. At the bottom of the screen, touch the **Back** button to return to the Input Preset screen.
10. Select the **Input Source** button. This will open the Input Select screen.  
The right side of the screen should display “**Current Input: Stereo2**”.  
If it is not displayed, return to the Input Setup screen by selecting the **Input** button and selecting **Stereo 2** in the **Current Input** drop down menu. Return to the Input Select screen by touching the **Input Source** button.
11. In the Analog input section, touch the **Stereo1 L/R** option to change it to **Stereo2 L/R**. Then touch the **Back** button to return to the Input Preset screen.
12. In the Input Setup screen, select the **Input Options** button to go to the Input Options screen.
13. In the Input Options screen, you can (if necessary) set the **Global Delay** for the selected input. Select the **Global Delay and Surround Offset** button. Select the **Global audio delay** button and turn the knob to increase or decrease the delay. Then touch the **Back** button to return to the Input Preset screen.
14. Select the **Stereo Level** button to change input gain on Left and Right to 1.0 dB. Select the L or R button and turn the knob to increase or decrease the gain.  
Touch the **Back** button to return to the Input Preset Setup screen.

## 4.0 Setup Menus

This section describes the RS20i setup menus. The full menu structure of the RS20i is illustrated on the next five pages. Following that is a detailed explanation of each screen and functionality.

### 4.1 Navigating the Setup Menus

Select the **SETUP** button from the Home screen to access the Setup menus. The Setup menus are intended for use **ONLY** by a qualified installer. Password protection is highly recommended to prevent unauthorized access. See 4.8.3 Access Control, page 91, to set the Setup password.

The Setup screen is the primary access to many additional sub menus. It is described fully beginning with section 4.2, page 35

The setup screen displays the five main setup groups, Input, EQ, Output Preset, Automation, and System. Each of these groups contains sub menu selections that pertain to that group.

Once you have navigated through sub-menus, selecting the **Setup** button always returns you to the initial Setup screen. Selecting the **Home** button from any menu will return to the Home screen (the main operator menu).

If **SETUP** is then reselected, the RS20i returns to the last selected sub-menu.

The **Back** button works like the back button of an internet browser, and may be used to return through the history of previously selected sub-menus.

If the  symbol appears on the screen, it indicates that the front panel Volume Control/Adjustment knob may be used as a navigation tool to scroll through a list of items or text.

In the next sections, we will discuss in detail the options available through the Setup screen.

**Note: When using a laptop to VNC into the RS20i, use the up and down arrows to mimic the scrolling action of the front panel Volume Control knob.**

**Note: The factory default VNC password is the hyphen “-“ symbol.**

## RS20i Menu Structure

Software V1.03.03 and above  
Page 1

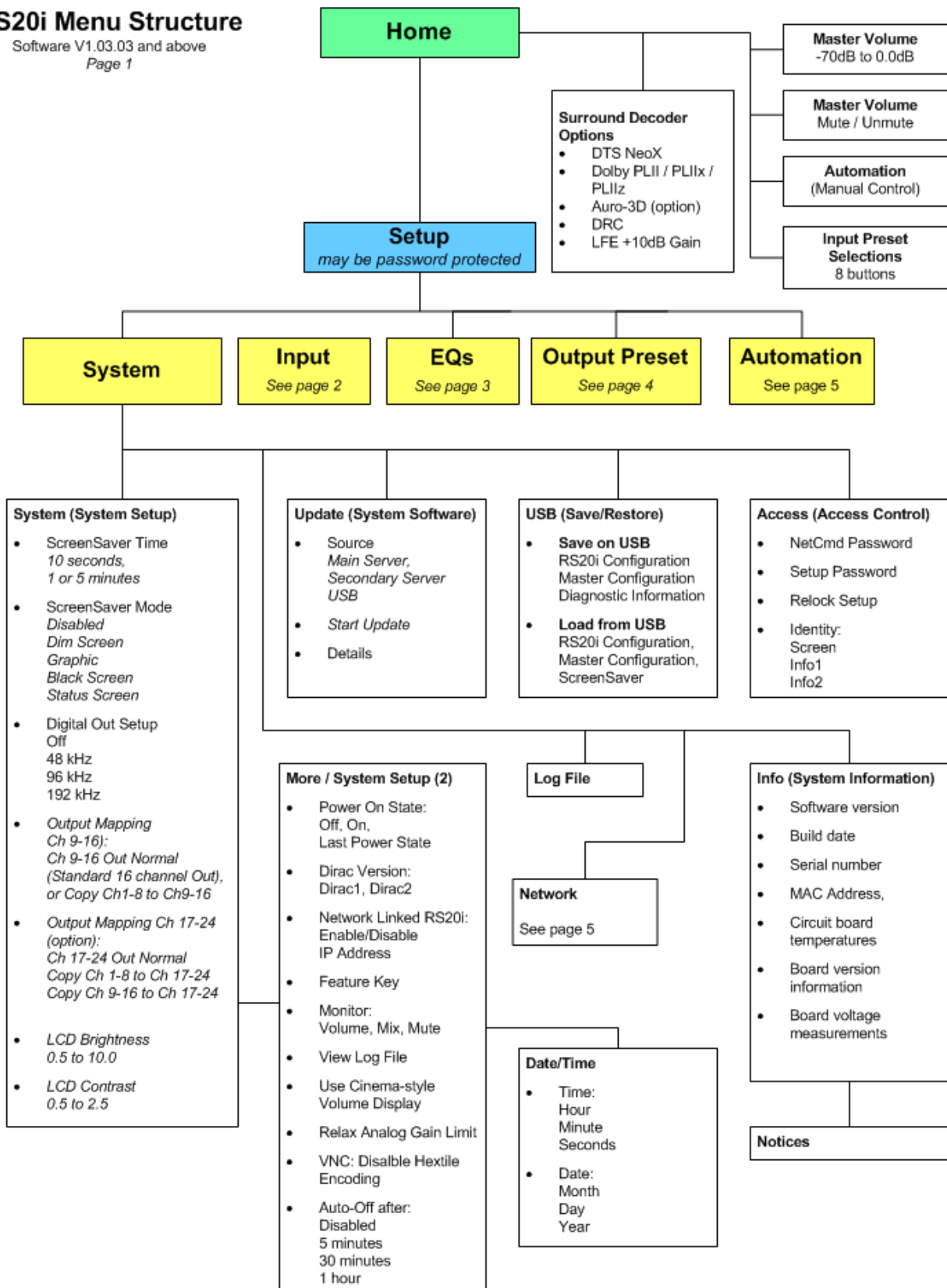

## RS20i Menu Structure

Software V1.03.03 and above  
Page 2

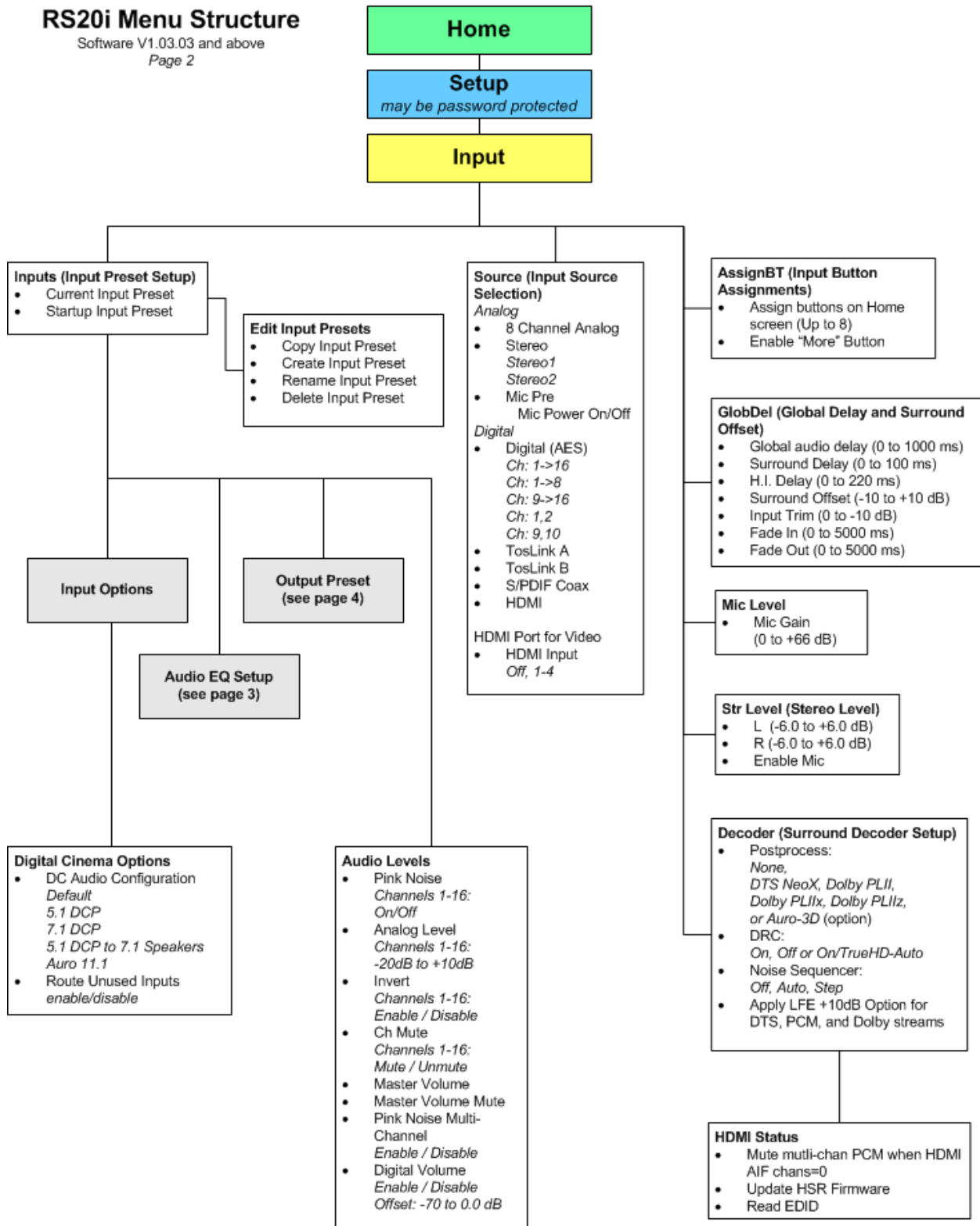

## RS20i Menu Structure

Software V1.03.03 and above  
Page 3

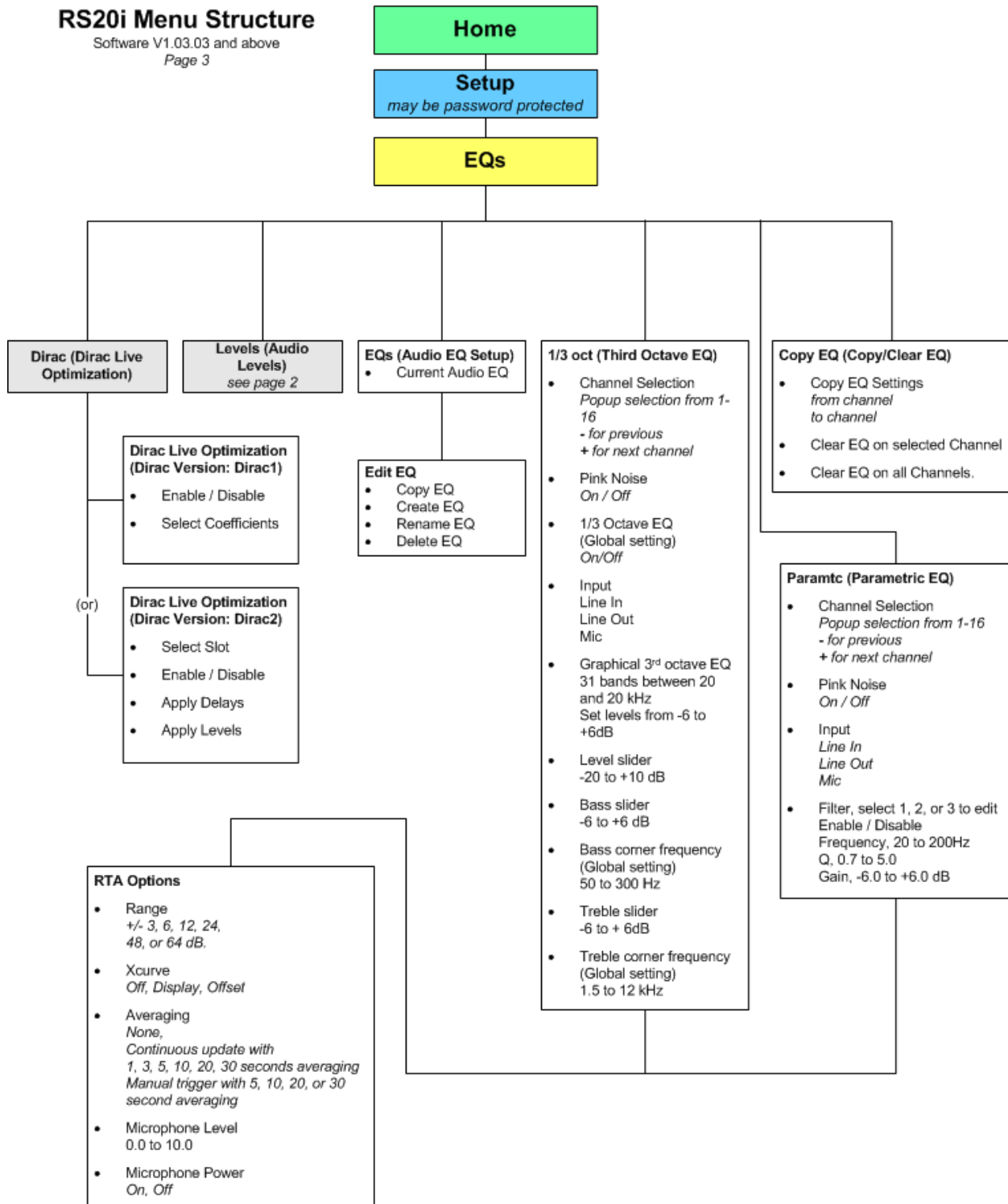



## RS20i Menu Structure

Software V1.03.03 and above  
Page 4

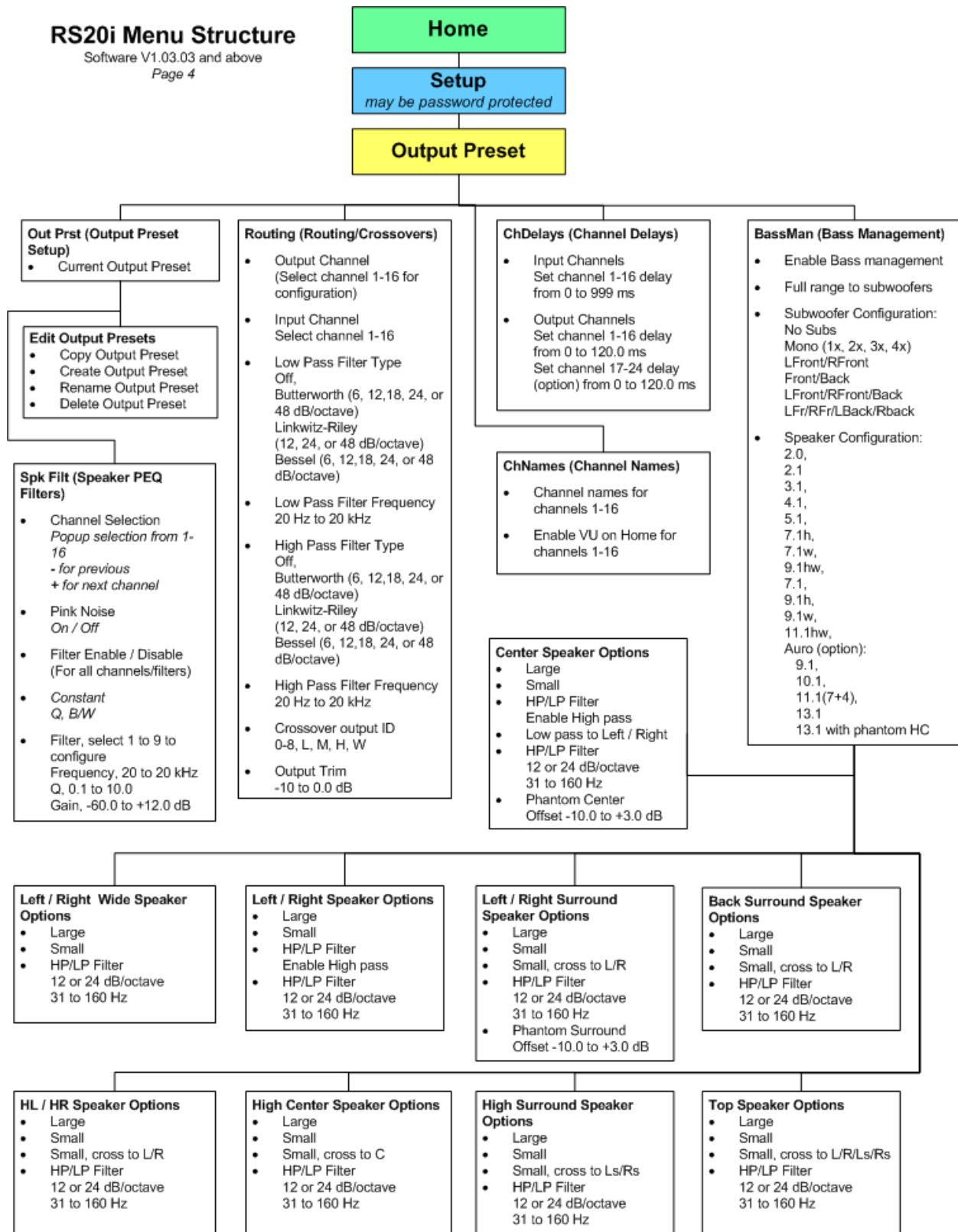

## RS20i Menu Structure

Software V1.03.03 and above  
Page 5

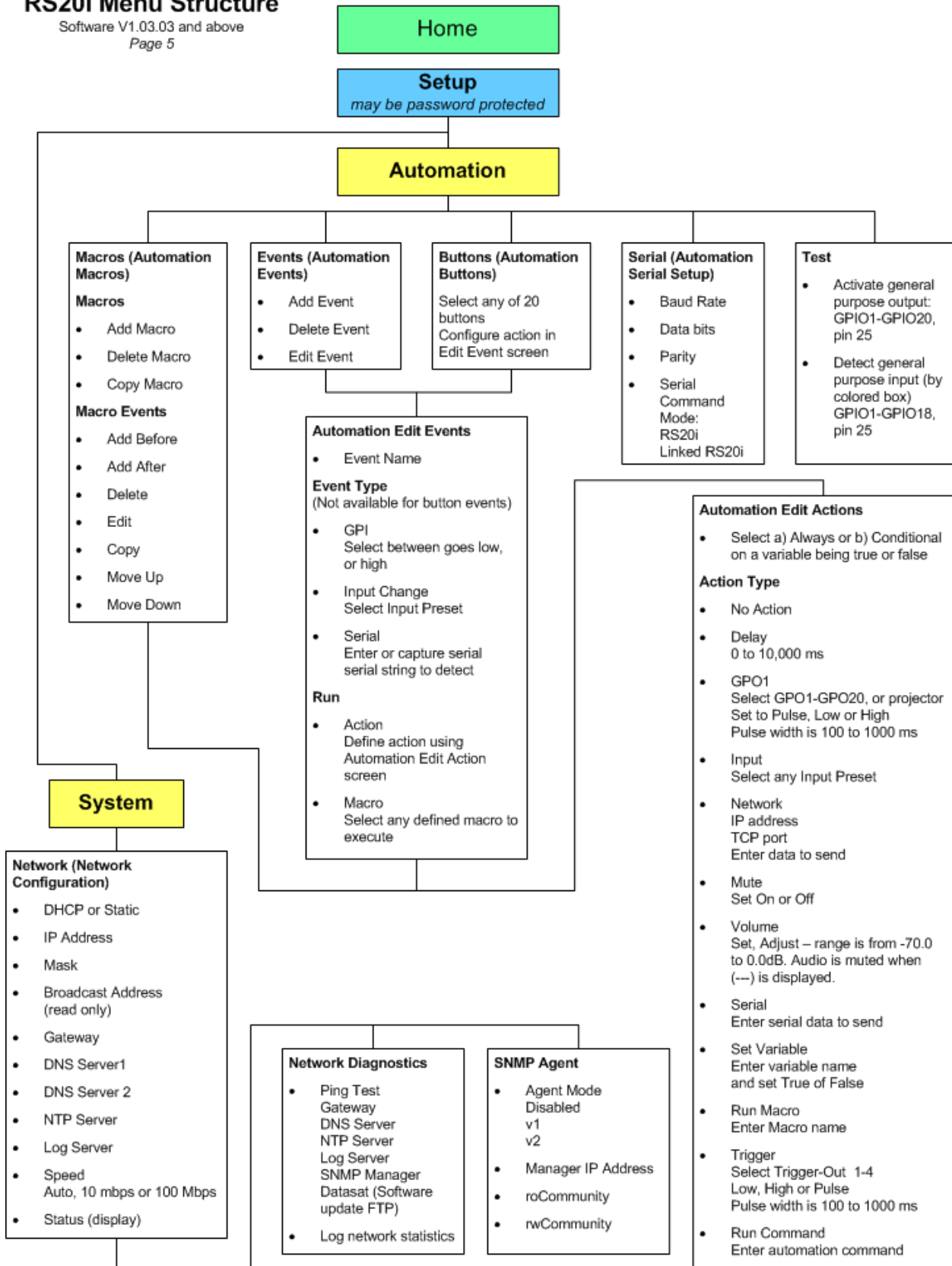

## 4.2 Setup Screen

To access this screen:

Home >SETUP



Figure 16. Setup Screen

From the **Setup** screen, you can configure or select the following:

- Inputs group
  - Inputs – See 4.2.1 *About Input Presets*, page 36 and 4.3 Input Preset Screen, page 38.
  - Source – See 4.3.4 *Input Source*, page 43.
  - AssignBt – See 4.3.2 *Input Button Assignments*, page 42.
  - GlobDel – See 4.3.5.1 *Global Delay and Surround Offset*, page 46.
  - Mic Level – See 4.3.5.4 *Mic Level*, page 48.
  - Str Level – See 4.3.5.3 *Stereo Level*, page 47.
  - Decoder – See 4.3.6 *Surround Decoder Setup*, page 48.
- EQs group
  - EQs – See 4.4.1 *Edit EQ*, page 54.
  - Dirac – See 4.4.2 *Dirac Live Optimization*, page 55.
  - 1/3 Oct – See 4.4.3 *Third Octave EQ*, page 56.
  - Paramtc – See 4.4.4 *Parametric Equalization*, page 60.
  - Copy EQ – See 4.4.5 *Copy/Clear EQ*, page 61.
  - Levels – See 4.4.6 *Audio Levels*, page 62.
- Output Preset group
  - Out Prst – See 4.5 *Output Preset*, page 64.
  - ChNames – See 4.5.2 *Channel Names*, page 68.
  - Routing – See 4.5.3 *Routing/Crossovers*, page 69.
  - ChDelays – See 4.5.4 *Channel Delays*, page 71.
  - BassMan – See 4.6 *Bass Management Setup*, page 73.
- Automation group
  - Macros – See 4.11 *Automation Macros*, page 101.

- Events – See 4.13 *Automation Events*, page 105.
- Buttons – See 4.14 *Automation Buttons*, page 106.
- Serial – See 4.15 *Automation Serial Setup*, page 108.
- Test – See 4.16 *Automation GPIO Test*, page 108.
- System group
  - System – See 4.8 *System Setup*, page 86.
  - Update – See 4.8.1 *Update System Software*, page 87.
  - USB – See 4.8.2 *USB Save/Restore*, page 89.
  - Log File – See 4.9.2 *Log File*, page 97.
  - Info – See 4.8.4 *System Info*, page 92.
  - Network – See 4.10 *Network Configuration*, page 98.
  - Access – See 4.8.3 *Access Control*, page 91.

## 4.2.1 About Input Presets

The RS20i facilitates the process of creating customized audio input presets. While the RS20i comes with a set of pre-built Input Presets (see table below), an installer normally adds Input Presets, as well as deletes or changes the existing pre-built presets to fit the requirements of the installation. We use the term “Input Preset” to mean a selection that includes not only the input source, but additional configuration items that have been set for that input source. An Input Preset consists of an Input Source, Input Options, EQ Setup, and an Output Preset, as illustrated below in Figure 17.

Each **Input Preset** created is given a text name that identifies the preset. The name should be descriptive to make it easily identifiable by the user. Identifying names are also given to **EQ Setups** and **Output Presets**.

The buttons along the bottom of the RS20i **Home** screen are the Input Presets that are defined by the installer for a particular application. If more than 8 input presets are created, then button 8 may be programmed as the **More** button which allows access to all available Input Presets through a pop-up window.

The EQ Setup and Output Presets are named groups of settings. Each Input Preset is assigned an EQ Setup and an Output Preset. A single EQ Setup may be used for all Input Presets, or unique EQ Setups may be created and assigned to different Input Presets. The same idea applies to Output Presets.

The RS20i holds a maximum of 20 separate **Input Presets**, 20 separate **EQ Setups** and 20 **Output Presets**.

Figure 17 shows specifically which configuration items are included in an **EQ Setup** or **Output Preset**. **Input Options** configurations are also shown. Some **Input Options** are applicable only for specific Input Sources. The chart displays what Input Source must be selected for each **Input Option** configuration item. Global configuration items are those that are not assigned with the Input Preset. Global configuration includes items such as System Setup, Automation and Network configuration.

Changes in an **EQ Setup** configuration item are saved with the currently selected **EQ Setup**. Changes in an **Output Profile** configuration item are saved with currently selected **Output Profile**. Changes in **Input Options** are saved with the currently selected **Input Preset**.

**Note: Use this chart in Figure 17 to determine what group a specific configuration item belongs to, when creating multiple EQ Setups or Output Profiles.**

**Table 5. RS20i Factory Presets**

Input Name	Assigned Button	Signal Source	EQ Set	Output Preset
HDMI 1	1	HDMI Port 1	EQ1	7.1
HDMI 2	2	HDMI Port 2	EQ1	7.1
Digital1	3	Digital Ch: 1-8	EQ1	7.1
TOS A	4	TosLink A	EQ1	7.1
SPDIF	5	S/PDIF Coax	EQ1	7.1
Analog	6	Analog 8Chan	EQ1	7.1
Stereo 1	7	Stereo1	EQ1	7.1

The default EQ set is named EQ1 and includes all EQ settings flat and all filters off. This EQ set may be used and altered during the theater setup process. The default output preset is 7.1, which includes the default 8-channel assignments and trim values flat.

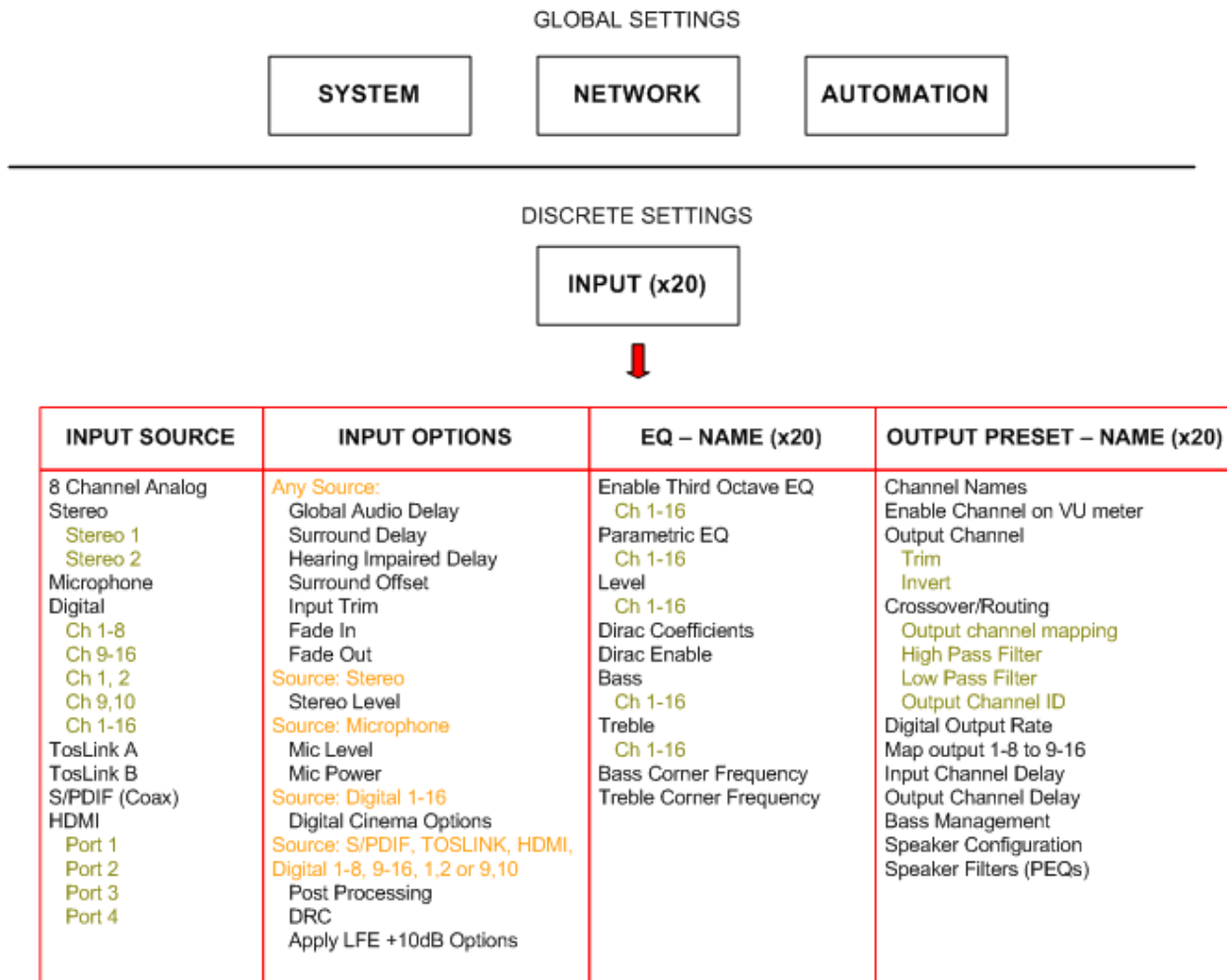

Figure 17. Global Settings and Input Discrete Settings

## 4.2.2 Overview, Creating an Input Preset

This is an overall summary of the procedure for creating an audio input. Each is described in more detail later in this section.

Assign **Input Preset** name. The RS20i comes with some Input Presets already installed which have general names reflecting the input source. These Input Presets should be renamed to describe specific installation inputs and/or configuration. Additional Input Presets can be created by copying an existing Input Preset, or by creating a new Input Preset from a template. Unused Input Presets may be deleted. All of these functions are available in the Input Setup screen.

**Input Source.** Define the physical input connector in the Input Source screen.

**Input Options.** Set Global Delay, Surround Decoder, and other options for the Input Preset. These are all found under the Input Options selection.

**Output Preset.** Select the Output Preset desired for the Input Preset. This is set by entering the Output Preset Setup screen and selecting the Current Output Preset using the list selection. The Output Preset contains the channel names, Bass Management, channel delays, and crossover settings. See 4.5 *Output Preset* on page 64 to create or configure an output preset.

**EQ Setup.** Select the EQ Setup desired for the Input Preset. This is set by entering the Audio EQ Setup screen and selecting the Current Audio EQ Setup using the list selection. The Audio EQ contains the Dirac Coefficients, 3rd Octave EQ, Parametric EQ, etc. See 4.4 Audio EQ Setup on page 53 to create or configure an EQ Setup.

**Assign Buttons.** You can assign up to eight Input Preset buttons on the Home screen to provide quick access to select an Input Preset. Optionally, one of the buttons can be assigned to have a pop-up where up to 20 Inputs can be selected. This function is available in the Assign Buttons screen.

## 4.3 Input Preset Screen

The Input Preset screen is the base screen for creating and configuring an Input Preset. To access this screen:

**Setup > Inputs**

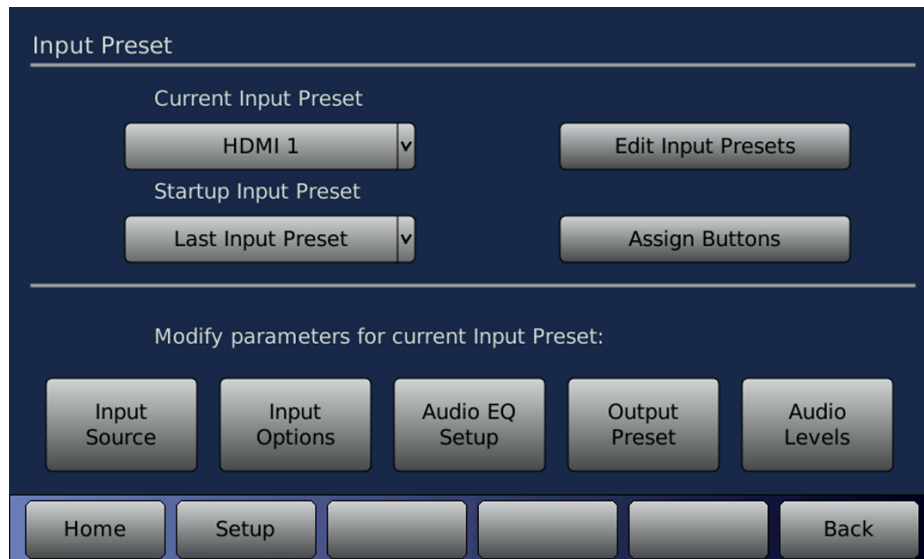

Figure 18. Input Preset Screen

From the Input Preset screen, you can configure or select the following:

- Current Input Preset – See *Current Input Preset*, page 39.
- Startup Input Preset – See *Startup Input Preset*, page 40.
- Edit Input Presets – See 4.3.1 *Edit Input Presets*, page 40.
- Assign Buttons – See 4.3.2 *Input Button Assignments*, page 42.
- Input Source – See 4.3.4 *Input Source*, page 43.
- Input Options – See 4.3.5 *Input Options*, page 45.
- Audio EQ Setup – See 4.4 *Audio EQ Setup*, page 53.
- Output Preset – See 4.5 *Output Preset*, page 64.
- Audio Levels – See 4.4.6 *Audio Levels*, page 62.

## Current Input Preset

Select the Input Preset you wish to modify from the drop-down list of installed inputs. This is a convenient way to select the Input Preset for configuration without going to the Home screen. Touch the drop down list to open it, then touch the input name to select it. This will become the current Input Preset.

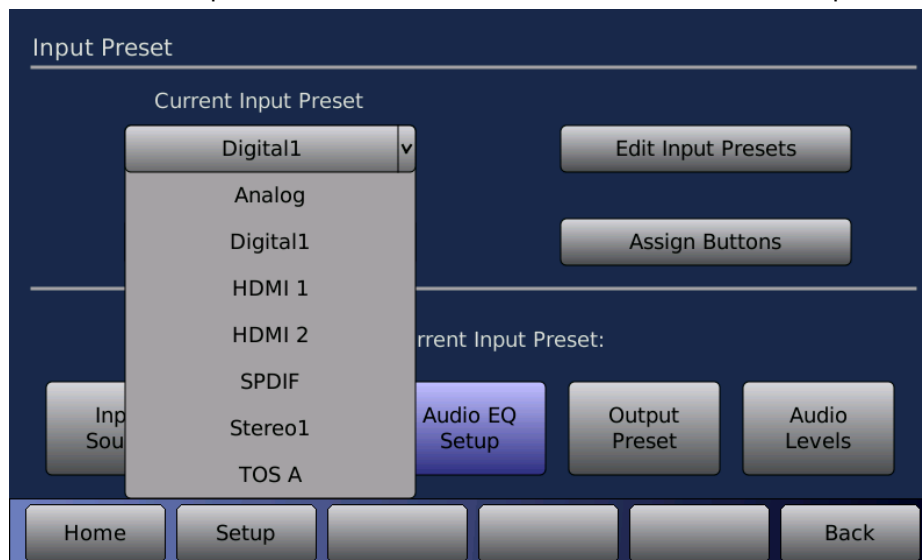

Figure 19. Select Current Input Preset

## Startup Input Preset

The Startup Input Preset is the default Input Preset when the RS20i is powered up. Select any defined Input Preset or **Last Input Preset**. Touch the drop down list to open it, then select the Input Preset. Use the Volume Control knob to scroll the list, if necessary.

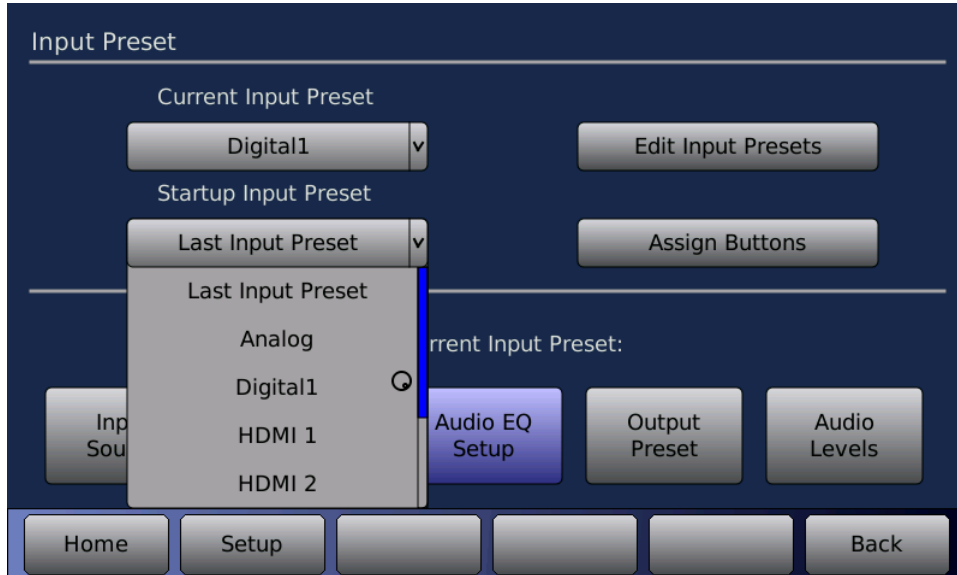

Figure 20. Select Startup Input Preset

### 4.3.1 Edit Input Presets

The Edit Input Presets screen permits copying, renaming, and deleting Input Presets. To access this screen:

**Setup > Inputs > Edit Input Presets**

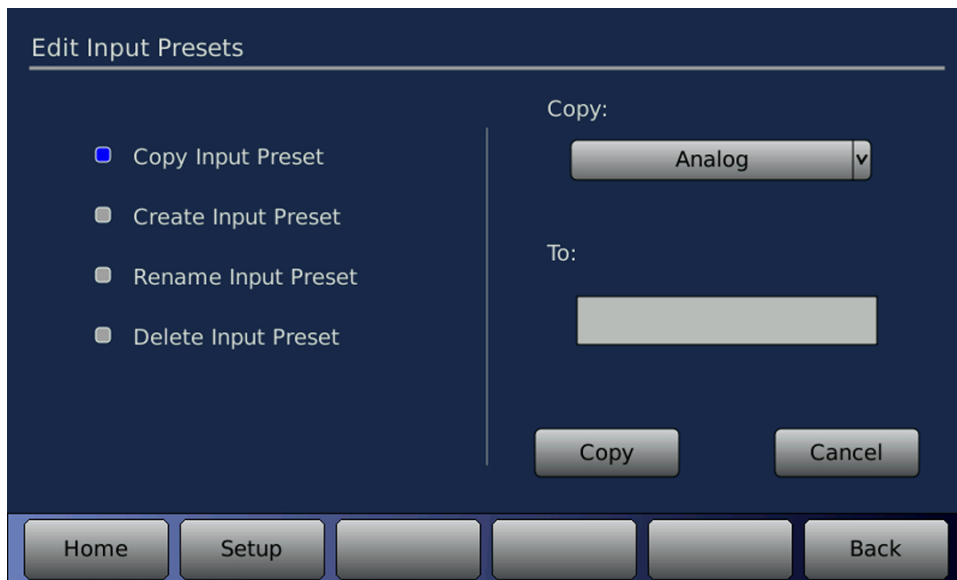

Figure 21. Edit Input Presets Screen

The functions available on this screen are described in the table below.



**Table 6. Edit Input Presets**

Function	Description
<b>Copy Input Preset</b>	<p>Use an existing Input Preset as a template for a new one.</p> <ul style="list-style-type: none"> <li>▪ Select the Input Preset you wish to copy from by selecting it from the <b>Copy</b> drop down list.</li> <li>▪ Then, touch the <b>To</b> box to bring up the virtual keyboard and enter a name for the new Input Preset.</li> <li>▪ Press the <b>Copy</b> button to complete the process, or press <b>Cancel</b> to quit.</li> </ul>
<b>Create Input Preset</b>	<p>Select one of the pre-installed Input Presets in your RS20i and use it as a template for a new one. The Input Preset is created with the Input Source as described by the Input Preset name, and retains the Current EQ Setup and current Output Preset.</p> <ul style="list-style-type: none"> <li>▪ Select the Input Preset from the <b>Create, using template</b> drop down box.</li> <li>▪ Then, touch the <b>To</b> box to bring up the virtual keyboard and enter a name for the new Input Preset.</li> <li>▪ Press the <b>Create</b> button to complete the process, or press <b>Cancel</b> to quit.</li> </ul>
<b>Rename Input Preset</b>	<p>Give an existing Input Preset a new name.</p> <ul style="list-style-type: none"> <li>▪ Select an existing Input Preset from the drop-down list on the right side of the screen.</li> <li>▪ Touch the <b>To</b> box to bring up the virtual keyboard and enter a new name for the Input Preset.</li> <li>▪ Press the <b>Rename</b> button to complete the process, or press <b>Cancel</b> to quit.</li> </ul> <p><b>Note:</b> Renaming the Input Preset will also change any references to that Input Preset, such as the button assignment or the Input Preset used on <b>Macros</b> and <b>Events</b>.</p>
<b>Delete Input Preset</b>	<ul style="list-style-type: none"> <li>▪ Select an existing Input Preset from the <b>Delete</b> drop-down list on the right side of the screen.</li> <li>▪ Press the <b>Delete</b> button to complete the process, or press <b>Cancel</b> to quit.</li> </ul> <p><b>Note:</b> An Input Preset may not be deleted if it is referenced by a Button Assignment or an Automation Event. A pop-up message will appear if the Input Preset cannot be deleted. In that case, references to that Input Preset must first be removed in order to delete the Input Preset.</p>

### 4.3.2 Input Button Assignments

In the Input Button Assignments screen, you can assign specific Input Presets to buttons that appear on the **Home** screen. Up to 8 Input Presets may be assigned.

**Setup > Inputs > Assign Buttons**

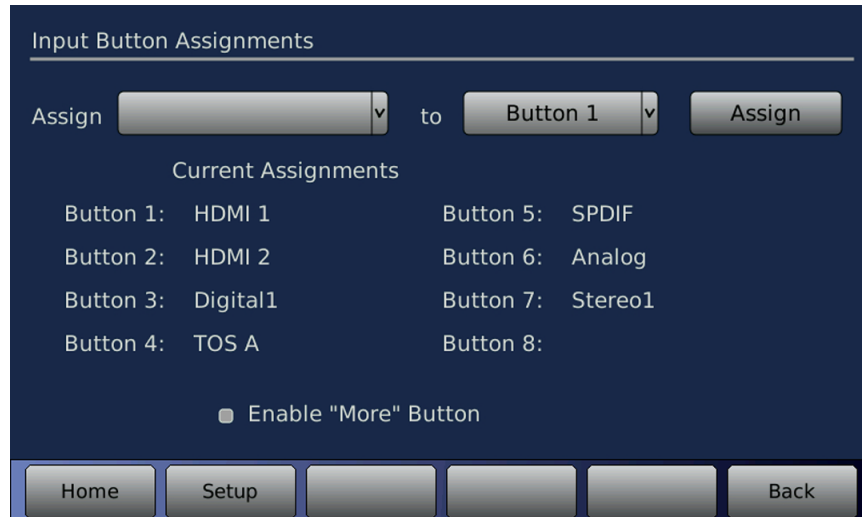

Figure 22. Input Button Assignments Screen

- Touch the **Assign** drop down list to open it, then select an input.
- Touch the **Button** drop down list to open it, then select a button number.
- Touch the **Assign** button.
- **Enable “More” Button** – see *Enable “More” Button*, page 43.

The button assignment will be listed in the **Current Assignments** listing in the screen above. Additionally, the Input Preset will be assigned to the corresponding button location along the bottom of the Home screen as shown in Figure 23.

**Note:** To un-assign or delete a button assignment, select the button from the drop down list, then select the *blank* option from the Assign drop down list, then touch Assign. The Current Assignments listing will no longer show the button assignment.

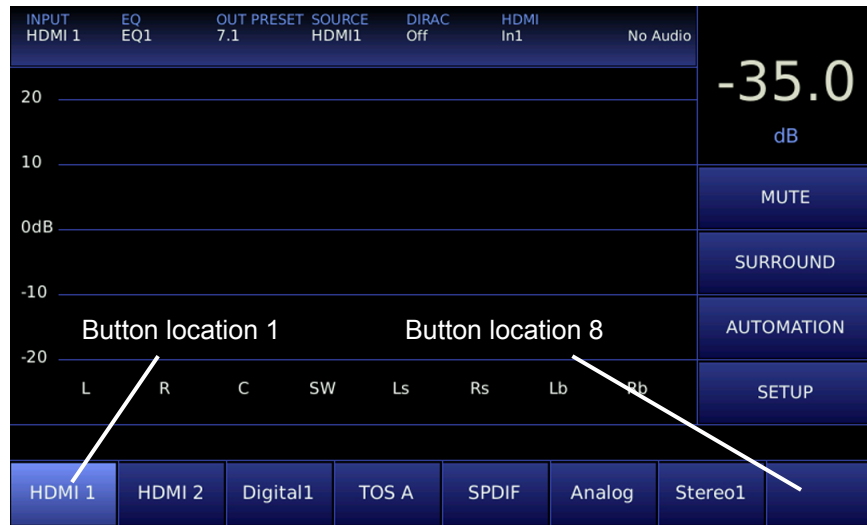

Figure 23. Home Screen Input Preset Button Locations

### 4.3.3 Enable “More” Button

When the **Enable “More” Button** is checked, Button 8 on the Home screen is labeled as **“More”** and allows access to additional **Input Presets**. Selecting the **More** button on the Home screen opens a pop-up window that displays all the available **Input Presets**. The user may select the desired Input Preset from the pop-up and the window will automatically close. Any selection made outside of the Input Presets buttons also closes the pop-up window without making any changes.

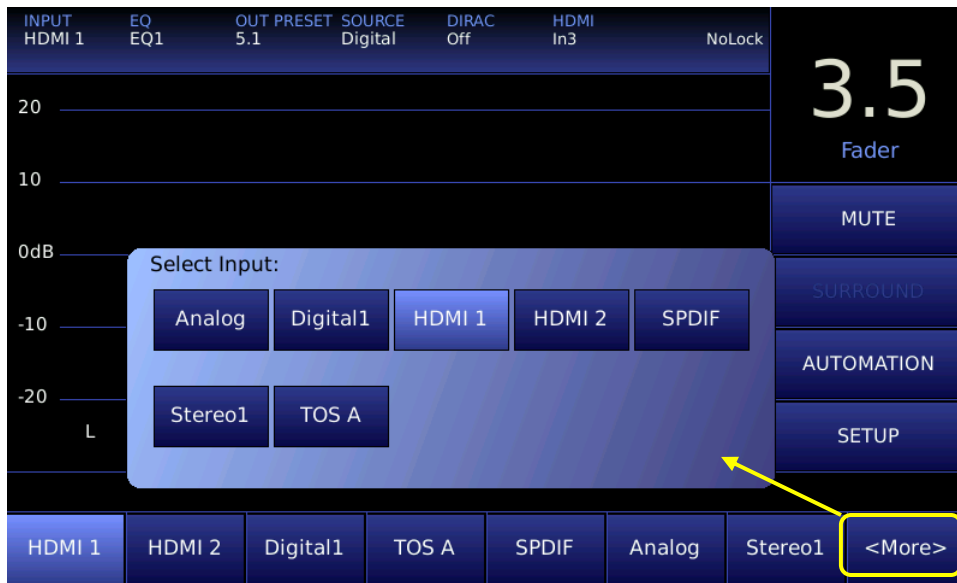

Figure 24. Home Screen <More> Input Select

### 4.3.4 Input Source

Navigate to the Input Source screen in order to select the source for the current Input Preset. Touch the desired input source buttons in the Analog or Digital group of buttons.

Setup > Inputs > Input Source

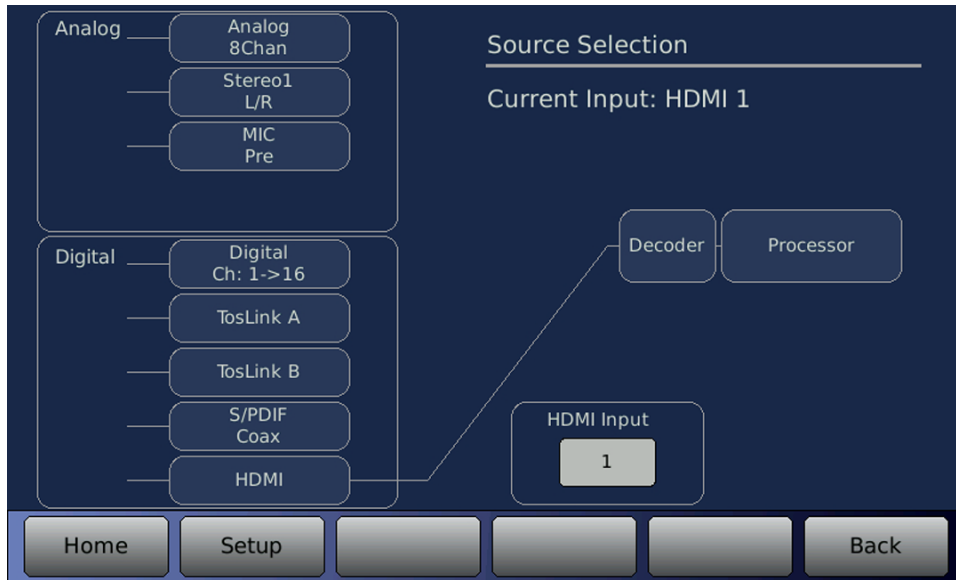

Figure 25. Input Source Screen

- If **Stereo** is selected, touching the button again toggles the selection between Stereo1 and Stereo2.
- If **Digital** is selected, touching the button again toggles the selection between Digital Ch: 1 > 8, Digital Ch 9 > 16, Digital Ch: 1-2, Digital Ch: 9-10 and Digital Ch: 1 > 16.

Table 7 shows where input channels are mapped within the RS20i.

**Table 7. Input Source Mapping**

INPUT		OUTPUT
Analog 8 Channel	<b>Maps to...</b>	Processor Channel 1 → 8
Stereo1 L/R		Processor Channel 1, 2 (L, R)
MIC Pre		Processor Channel 3 (Center)
Digital Channel 1 → 16		Processor Channel 1 → 16
Digital Channel 1 → 8		Processor Channel 1 → 8
Digital Channel 9 → 16		Processor Channel 1 → 8
TosLink A		Processor Channel 1 → 2 <sup>1</sup>
TosLink B		Processor Channel 1 → 2 <sup>1</sup>
S/PDIF Coax		Processor Channel 1 → 2 <sup>1</sup>
HDMI		Processor Channel 1 → 8
HDMI Input		HDMI Audio/Video Input port selection

1. If a DTS or Dolby Digital bitstream is detected and decoded, the decoded stream will be routed to the first eight channels internally on the RS20i. See section 4.3.6 *Surround Decoder Setup* on page 48 for more information.

### 4.3.5 Input Options

The Input Options screen provides access to options that are specific to the Input Preset. Some configuration options are only available for a specific input source that is configured for the Input Preset.

To access Input Options:

**Setup > Inputs > Input Options**

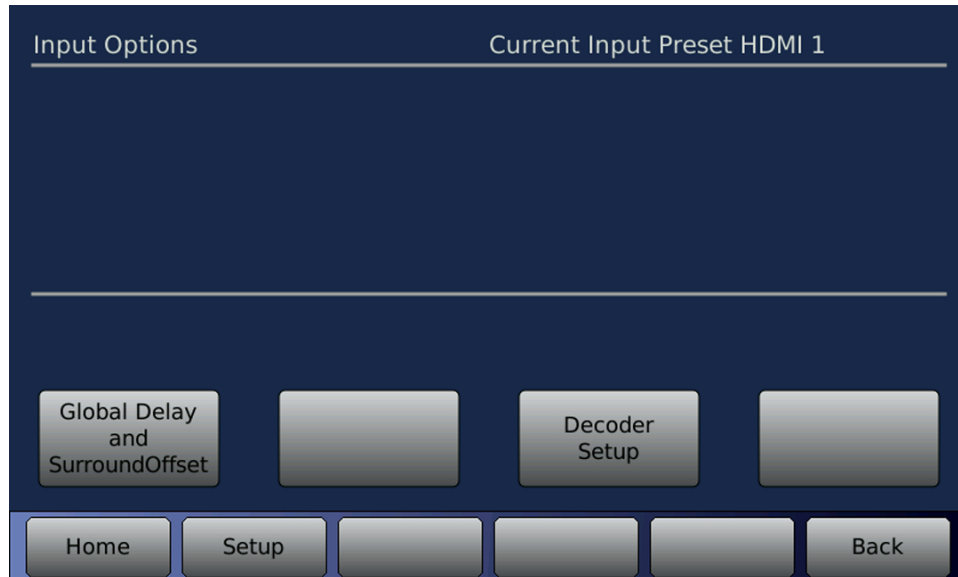

Figure 26. Input Options for an HDMI Input

The following Input Options sub-menus may appear:

- **Global Delay and Surround Offset** – This menu provides delays, offsets and trims that can be set for any Input Preset. See 4.3.5.1 Global Delay and Surround Offset, page 46.
- **Decoder Setup** – This menu provides decoder post processing options (Neo:X, Pro Logic IIx/IIz, Auro-3D), settings for DRC, Noise Sequencer, and LFE boost options. This menu is not available when the **Input Source** is **Digital 1-16** or **Mic** because the audio from these sources does not go through the decoder or Post Processor. See 4.3.6 *Surround Decoder Setup*, page 48.
- **Stereo Level** – This menu is used to adjust the Stereo input channel levels and is available only when the Input Source is set to **Stereo 1** or **Stereo 2**.
- **Mic Level** – This menu is used to adjust the Microphone input level and is available only when the Input Source is set to **Mic Pre**. See 4.3.5.4 Mic Level, page 48.
- **Digital Cinema Options** – This menu is used when the Input Source is Digital 1>16. See 4.3.7 Digital Cinema Options, page 52.

### 4.3.5.1 Global Delay and Surround Offset

The Global Delay and Surround Offset screen is available for all input sources.

**Setup > Inputs > Input Options > Global Delay and Surround Offset**

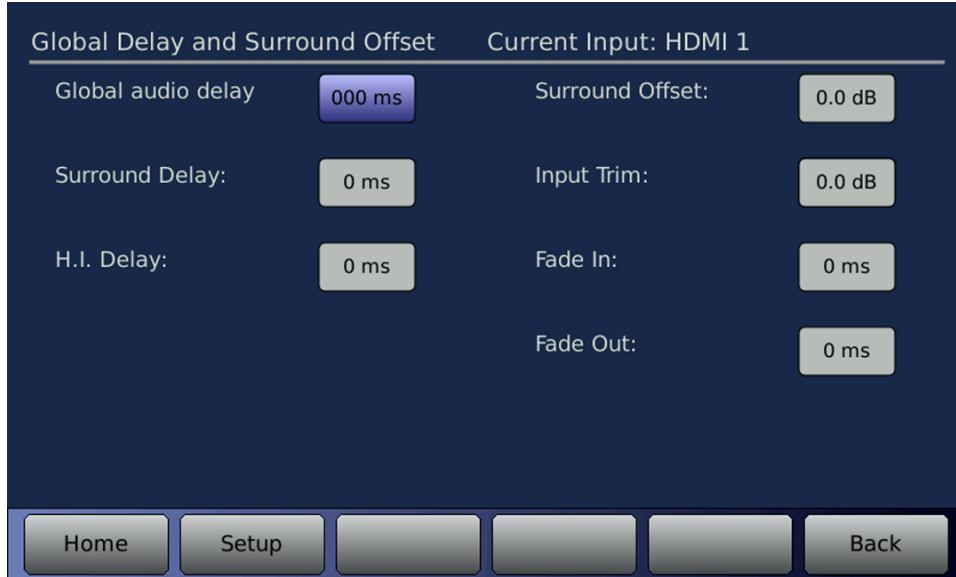

Figure 27. Global Delay and Surround Offset

The functions available on this screen are described in the table below.

**Table 8. Global Delay and Surround Offset**

Function	Description
<b>Global audio delay</b>	Audio can be delayed for a selected input, if necessary, to synchronize with a digital video projector. Use the Volume Control knob to adjust the audio delay (0 to 1000 ms). Delay values increase by 1 ms increments up to a maximum of 1 second.
<b>Surround Delay</b>	Enter the desired delay, in milliseconds, 0 to 100 ms. Select the Surround Delay box and then dial in the correct value using the front panel Volume Control knob. The surround delay is applied to the internal channels 5,6,7 and 8.
<b>H.I. (Hearing Impaired) Delay</b>	Audio can be delayed on the Hearing Impaired output channel. Enter the desired delay, in milliseconds, 0 to 220 ms.
<b>Surround Offset</b>	Use the Volume Control knob to adjust between -10dB to +10dB offset. Surround Offset is applied to the internal channels 5, 6, 7 and 8.
<b>Input Trim</b>	This can be used to apply volume level trim to the current input (0 to -10dB). This may be used when you want to balance the volume level of two different sources. The Input Trim allows you to change the master volume control level and keep the relative levels balanced.
<b>Fade In/Fade Out</b>	During an input change, the Fade In and Fade Out period can be set from 0 to 5000 ms (5 seconds). Use the Volume Control knob to set.

#### 4.3.5.2 Calculating the Surround Delay

Sound from the back of the theater should arrive at the listener's ears approximately 20 ms after the arrival of the front speaker sound. The following procedure describes how to arrive at the correct surround delay setting.

- Measure the distance between a **rear seat** and the nearest **surround speaker** in feet. If calculating in metric, convert meters to feet by multiplying by 3.
- Measure the distance from the **same rear seat** to the nearest **screen speaker**. If calculating in metric, convert meters to feet by multiplying by 3.
- Subtract surround distance from the screen distance, and add 20 (screen - surround + 20). The result is the surround delay in milliseconds.
- After setting the surround delay in the RS20i, verify the setting by listening to a familiar soundtrack. The action on-screen should match sound in the theater.

#### 4.3.5.3 Stereo Level

This screen is available for Input Presets that use the Stereo1 or Stereo2 input source.

**Setup > Inputs > Input Options > Stereo Level**

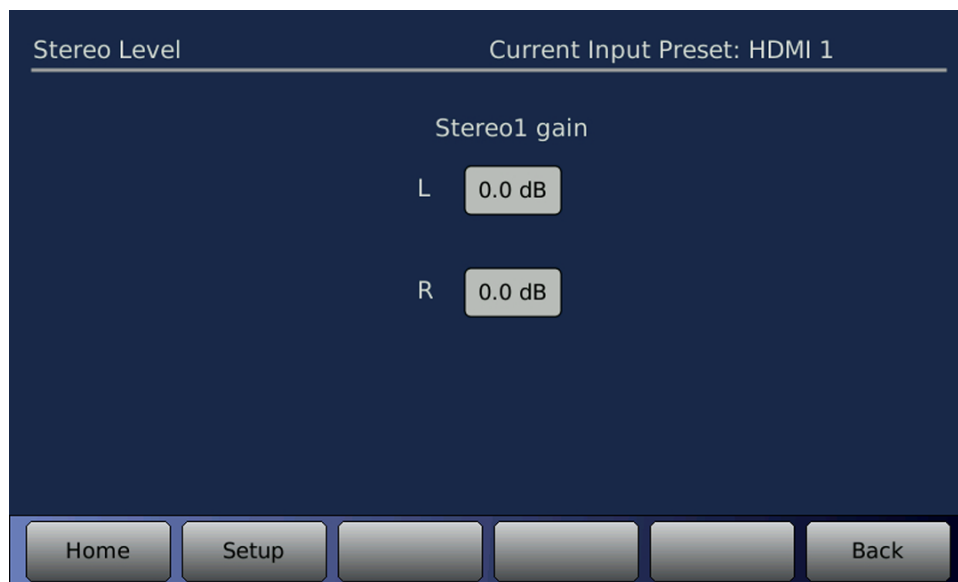

Figure 28. Stereo Level

Select Left or Right and adjust the gain (-6.0dB to +6.0dB) using the Volume control knob on the front panel.

#### 4.3.5.4 Mic Level

This screen is available for Input Presets that use the Mic Pre input source.

**Setup > Inputs > Input Options > Mic Level**



Figure 29. Mic Level

Adjust the Mic gain (-0dB to +66dB) by turning the Volume Control knob on the front panel.

#### 4.3.6 Surround Decoder Setup

This Input Option selection is available for Input Presets that have any Input Source selection other than **Mic Pre** and **Digital 1-16**. The menu path to access this screen is:

**Setup > Inputs > Input Options > Decoder Setup**

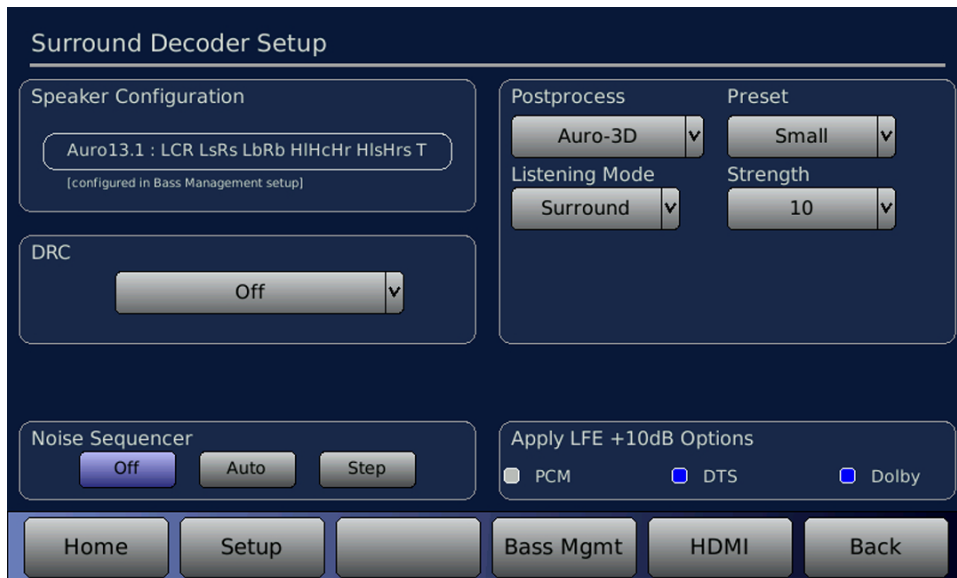

Figure 30. Decoder Setup

The controls available on this screen are described in the table below.



**Table 9. Decoder Setup**

Control	Description
<b>Speaker Configuration</b>	Displays the current Speaker Configuration. Changes to the Speaker Configuration can only be made in the Bass Management Setup screen. See 4.6 <i>Bass Management Setup</i> on page 73.
<b>DRC</b>	<p>Dynamic Range Control reduces the audio volume range between soft and loud sounds. The louder volumes are decreased and the quieter volumes increased. The amount that the range is reduced is determined dynamically by the metadata stream of the particular decoder that is being used. DRC works only with some Dolby or DTS content, depending on how it was created. Select from the drop down menu:</p> <ul style="list-style-type: none"> <li>▪ Off – no range control is applied</li> <li>▪ On/TrueHD Auto – range control is applied on TrueHD content only if enabled by the content. For DTS content, it is the same as ON.</li> <li>▪ On – it is applied by the DTS or Dolby decoder</li> </ul>
<b>Postprocess</b>	Select desired Post Processing method from the drop down menu: <b>None, DTS NeoX, Dolby Pro Logic, Dolby PLIIx, Dolby PLIIz, or Auro-3D</b> . The list will only display the selections valid for the Speaker Configuration. See 4.3.6.2 <i>Post Process Modes</i> , page 51.
<b>Noise Sequencer</b>	Selecting the Noise Sequencer outputs pink noise for setup or speaker tests. Select <b>Auto</b> to cycle pink noise through the channels, with each channel receiving pink noise for a few seconds before moving to the next channel. Select <b>Step</b> to move through the channels one at a time. Channels that are not active in the current Speaker Configuration are skipped. The Subwoofers are not included.
<b>Apply LFE +10dB Options</b>	<p>It removes the +10dB LFE (sub woofer) boost applied to the LFE channels when playing PCM, DTS, or Dolby decoded audio.</p> <p><b>Note:</b> LFE Adj is only required when playing old DTS discs that did not have correct LFE encoding level. Normally it should be +10 dB, the same as for Dolby.</p>

### 4.3.6.1 Surround Decoder Operation

The RS20i monitors the selected input signal to determine the type of audio signal received. If a DTS, DTS-HD or Dolby Digital bitstream is detected, the RS20i decodes the audio and places it on the first 8 channels (see Table 10, below).

If an un-encoded digital signal is received (such as 2-channel PCM), the signal is routed to the first two channels in the RS20i (Left and Right) and the others remain muted. The HDMI also supports 6 or 8 channel un-encoded PCM signal. The RS20i will switch between stream types as the signal type changes. This occurs automatically within the RS20i.

**Table 10. Decoder Channel Assignments**

<b>Channel Number</b>	<b>channel name</b>
1	Left (L)
2	Right (R)
3	Center (C)
4	Sub Woofer (SW)
5	Left Surround (Ls)
6	Right Surround (Rs)
7	Left Back (Lb)
8	Right Back (Rb)
9	High Left (HL)
10	High Right (HR)
11	High Left Surround (HLs) or Left Wide (Lw)
12	High Right surround (HRs) or Right Wide (Rw)
13	—
14	—
15	High Center (HC)
16	Top (T)

### 4.3.6.2 Post Process Modes

The table below shows which processing modes are available for different speaker configurations. For descriptions of the different processing modes, see 1.4.2 *Surround Mode*, on page 15.

**Table 11. Speaker Configurations**

Speaker Configuration	Option 1	Option 2	Option 3	Option 4	Option 5
2.0	None	Auro-3D			
2.1	None	Auro-3D			
3.1	None	DTS Neo:X	Dolby PLII		
4.1	None	DTS Neo:X	Dolby PLII		
5.1	None	DTS Neo:X	Dolby PLII	Auro-3D	
7.1 h	None	DTS Neo:X	Dolby PLIIz	Dolby PLII	
7.1 w	None	DTS Neo:X	Dolby PLII		
9.1 hw	None	DTS Neo:X	Dolby PLIIz	Dolby PLII	
7.1	None	DTS Neo:X	Dolby PLIIx	Auro-3D	
9.1h	None	DTS Neo:X	Dolby PLIIz	Dolby PLIIx	
9.1w	None	DTS Neo:X	Dolby PLIIx		
11.1 hw	None	DTS Neo:X	Dolby PLIIz	Dolby PLIIx	
Auro 9.1	None	DTS Neo:X	Dolby PLIIz	Dolby PLII	Auro-3D
Auro 10.1	None	DTS Neo:X	Dolby PLIIz	Dolby PLII	Auro-3D
Auro 11.1	None	DTS Neo:X	Dolby PLIIz	Dolby PLII	Auro-3D
Auro 11.1 (7+4)	None	DTS Neo:X	Dolby PLIIz	Dolby PLIIx	Auro-3D
Auro 13.1	None	DTS Neo:X	Dolby PLIIz	Dolby PLIIx	Auro-3D

### 4.3.7 Digital Cinema Options

These options are specifically designed for connecting audio from a 16-Channel Digital Cinema Server to the digital input connector(s). This option is available only for the 16 channel digital input (Source: Digital Ch: 1 to 16). To access this screen:

**Setup > Inputs > Input Options > Digital Cinema Options**

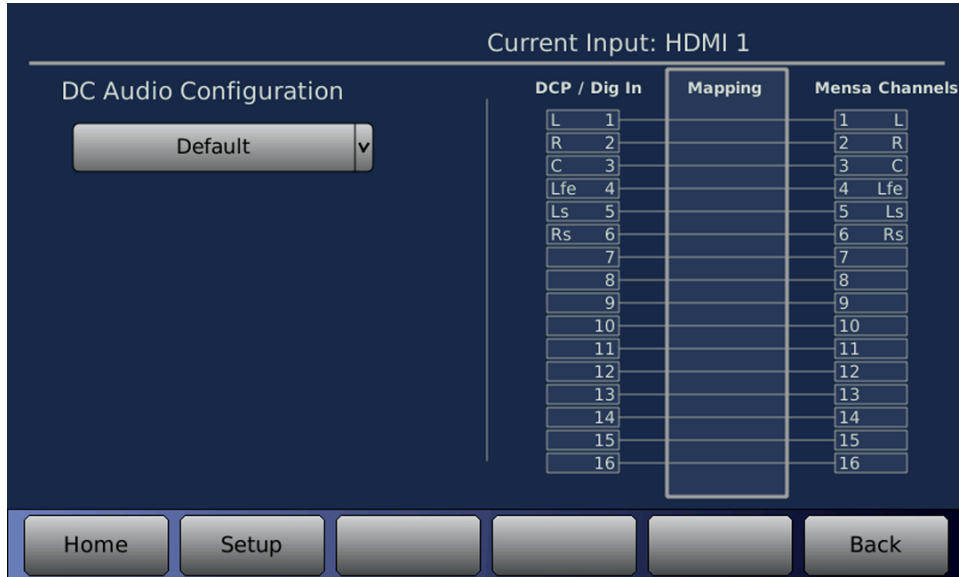

Figure 31. Digital Cinema Options

Select the DC Audio Configuration from the drop-down. Options are described in the table below.

**Table 12. DC Audio Configuration**

Configuration	Description
<b>Default</b>	All Digital Inputs are mapped to RS20i channels.
<b>5.1 DCP</b>	Same as Default, but if <b>Route Unused Inputs</b> is NOT selected, unused Digital Inputs are not mapped to RS20i channels.
<b>7.1 DCP</b>	Same as 5.1 DCP, with the addition of Lb and Rb inputs.
<b>5.1 DCP to 7.1 Speaker</b>	Same as 5.1 DCP, but Ls and Rs inputs are mapped to Lb and Rb as well as Ls and Rs channels.
<b>Auro 11.1</b>	Same as 5.1 DCP, plus HL, HR, HC, T, HLs, and HRs inputs are mapped to respective RS20i channels.

## 4.4 Audio EQ Setup

The Audio EQ Setup screen allows you to set the Audio EQ for the current Input Preset and edit the EQ. It also provides access to menus for modifying parameters for the current Audio EQ.

### Setup > EQs

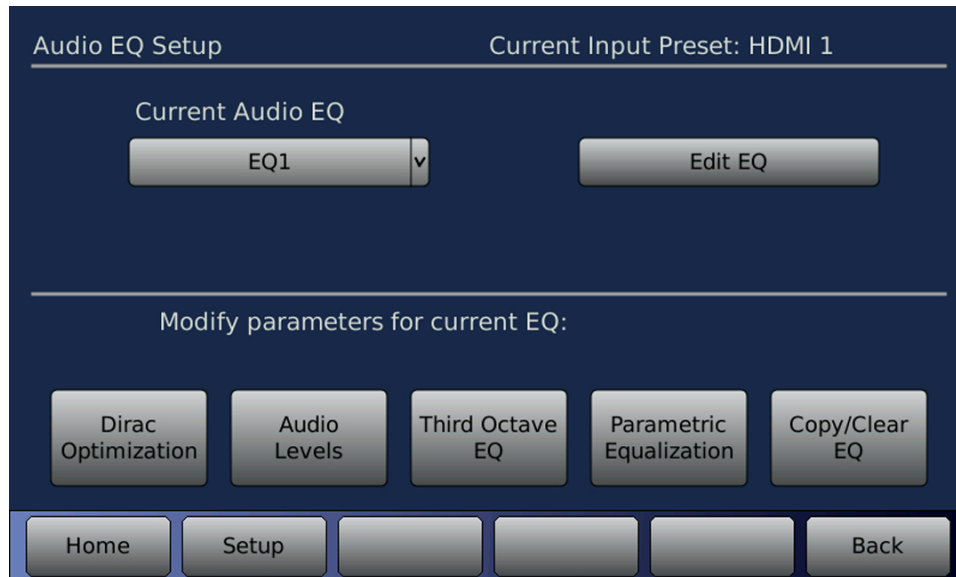

Figure 32. Audio EQ Setup Screen

Controls and links on this screen are described in the table below.

**Table 13. Audio EQ Setup**

Control or Link	Description
<b>Current Audio EQ</b>	This drop-down list allows you to select from the list of available EQ setups. The selection becomes the Audio EQ Setup for the current Input Preset.
<b>Edit EQ</b>	Copy, Create, Rename or Delete an Audio EQ Setup. See 4.4.1 <i>Edit</i> , page 54.
<b>Dirac Optimization</b>	Set up an audio optimization process. The button color turns light blue when Dirac is enabled. See 4.4.2 <i>Dirac Live Optimization</i> , page 55.
<b>Audio Levels</b>	See 4.4.6 <i>Audio Levels</i> , page 62.
<b>Third Octave EQ</b>	The button color turns light blue when Third Octave EQ has been set (non-flat) on at least one channel. See 4.4.3 <i>Third Octave EQ</i> , page 56.
<b>Parametric Equalization</b>	The button color turns light blue when at least one filter has been set (non-flat) on at least one channel. See 4.4.4 <i>Parametric Equalization</i> , page 60.
<b>Copy/Clear EQ</b>	See 4.4.5 <i>Copy/Clear EQ</i> , page 61.

### 4.4.1 Edit EQ

The Edit EQs button on the Audio EQ Setup screen opens the Edit EQ screen to Copy, Create, Rename or Delete an Audio EQ Setup.

**Setup > EQs > Edit EQ**

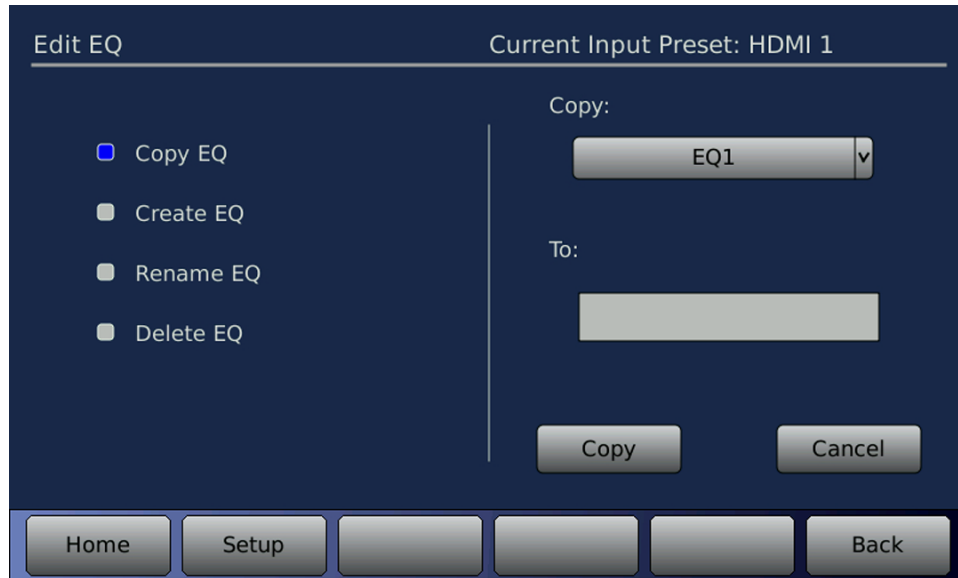

Figure 33. Edit EQ Screen

Functions on this screen are described in the table below.

**Table 14. Edit EQ**

Function	Description
<b>Copy EQ</b>	Use an existing EQ setup as a template for a new one. Select the EQ you wish to copy from by selecting it from the drop down box. Then, touch the <b>To</b> box to bring up the virtual keyboard and enter a name for the new EQ. Press the <b>Copy</b> button to complete the process, or press <b>Cancel</b> to quit.
<b>Create EQ</b>	Select an empty or clear EQ setup and use it as a template for a new one. Press the <b>Create</b> button to complete the process, or press <b>Cancel</b> to quit.
<b>Rename EQ</b>	Give an existing EQ setup a new name. Select an existing EQ setup from the drop-down list on the right side of the screen. Touch the <b>To</b> box to bring up the virtual keyboard and enter a new name for the EQ setup. Press the <b>Rename</b> button to complete the process, or press <b>Cancel</b> to quit.  <b>Note:</b> The EQ name is changed for all inputs that use the EQ.
<b>Delete EQ</b>	Select an existing EQ setup from the drop-down list on the right side of the screen. Press the <b>Delete</b> button to complete the process, or press <b>Cancel</b> to quit.

## 4.4.2 Dirac Live Optimization

Dirac Optimization is an audio optimization process that requires setup by using a separate external program running on a PC. The setup process creates a set of filter coefficients to improve sound based on a set of measured responses from the listening area.

The RS20i supports two versions of Dirac which are referred to as **Dirac 1** and **Dirac 2** in the menus. The **Dirac 1** version is the original, while **Dirac 2** is the latest and allows more flexibility in the setup process. Dirac 1 must be used to support old installations, and switching to Dirac 2 is recommended when the Dirac 2 installation software becomes available.

In order to use coefficients from the Dirac 1 setup program, the RS20i must be set for **Dirac 1** in the **System > More** screen. Likewise, in order to use coefficients from Dirac 2 setup, the RS20i must be set for **Dirac 2** in the **System > More** screen. Switching between Dirac 1 and Dirac 2 on the RS20i requires a power reset. You will see one of two possible Dirac menus depending on the Dirac version after the power reset.

### Setup > Dirac

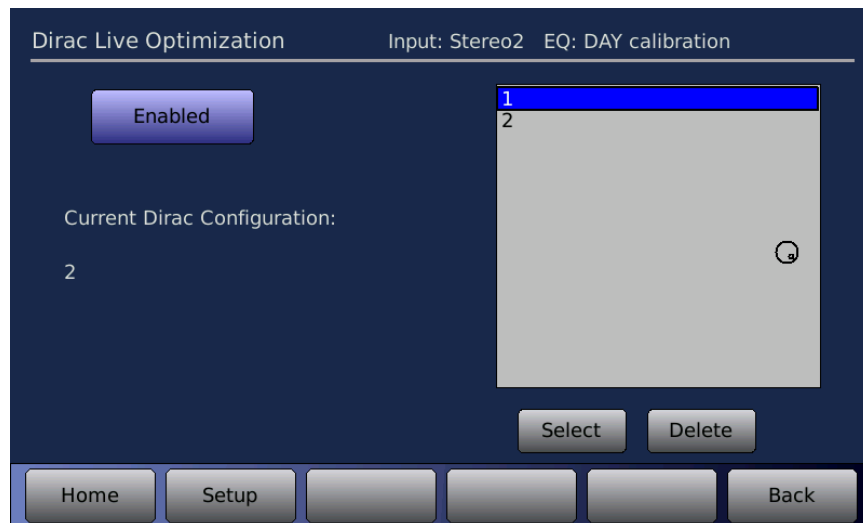

Figure 34. Dirac Optimization Screen

Functions on this screen are described in this table.

**Table 15. Dirac Live Optimization**

Function	Description
<b>Enabled/Disabled</b>	Toggle between enabling and disabling the Dirac Optimization.
<b>Current Dirac Configuration</b>	Displays the name of the current Dirac configuration.
<b>Select</b>	Select a configuration from the list of saved configurations (gray box above), then touch the <b>Select</b> button. This configuration will now become the current Dirac configuration.
<b>Delete</b>	Select a configuration from the list of saved configurations (gray box above), then touch <b>Delete</b> . The configuration will be deleted from the list and from the memory of the RS20i.

### 4.4.3 Third Octave EQ

Selecting the Third Octave EQ button from the EQ Setup screen will bring up a screen similar to that shown below.

Setup > 1/3 oct

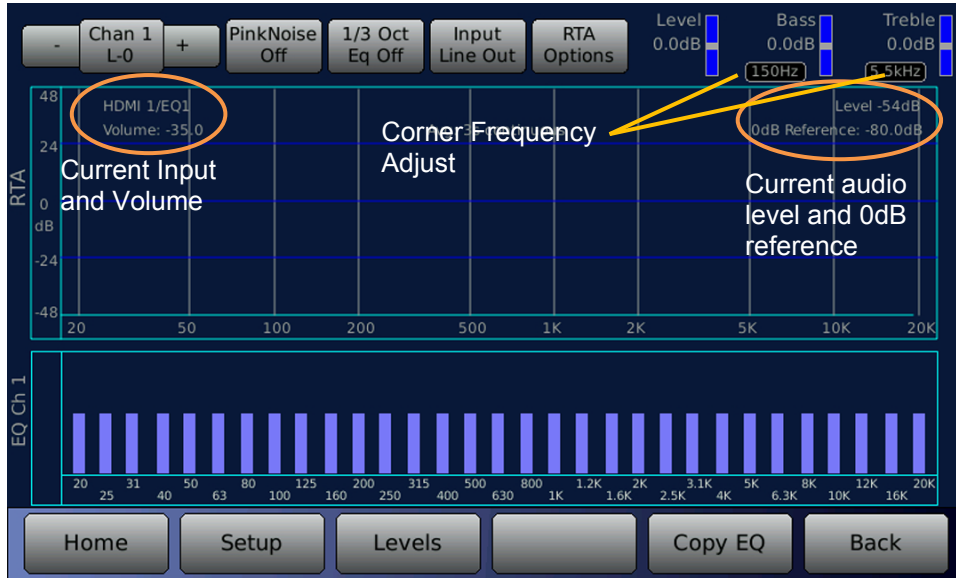

Figure 35. 1/3 Octave EQ Screen

The screen has an RTA (real time analyzer) on the top portion, and 1/3 octave adjustments on the bottom portion. In the upper left-hand portion of the RTA section, the current Input and current master volume control values are shown. In the upper right-hand portion, the current audio level and the 0 dB reference are displayed.

Note: Touching a blue bar in the EQ section (lower panel) will select that frequency and allow you to adjust the dB level of that frequency by rotating the Volume Control knob. (On the laptop running VNC, use the up/down arrow keys.)

Functions on this screen are described in this table.

Table 16. 1/3 Octave EQ

Function	Description
<b>Channel Number</b>	Touch the <b>Chan</b> button to bring up a pop-up window showing all sixteen channels. Select the channel you would like to equalize. You may also select the next channel by touching the <b>+</b> sign button to the right of the Chan button, or select the previous channel by touching the <b>-</b> sign button left of the Chan button. See 4.4.3.1 <i>Channel Number Selection</i> , page 58.
<b>Pink Noise On/Off</b>	Turns Pink Noise on or off.
<b>1/3 Oct Eequalization On/Off</b>	Turns 1/3 octave equalization on or off. This is a global setting that affects all channels.
<b>Input LineIn/LineOut/ Mic</b>	This selects the input source for the RTA. <b>LineIn</b> means that the signal source for the RTA is from the current input channel and does not have any processing (Dirac, EQ, etc). <b>LineOut</b> means that the signal source for the RTA is from the current output channel, so you would see the effects of the Dirac, EQ, etc. If



Function	Description
	<p>you are using the internal RTA to check the room tune, then you would select <b>Mic</b>.</p> <p><b>Note:</b> When the Input field is <b>LineIn</b>, the RTA selects the input channel. The controls for EQ, bass, treble, and trim represent what is applied to input channel and their effects will not show up on the RTA display.</p> <p>When the input field is set to <b>Mic</b>, the RTA selects the Mic input which will show the effects of the EQ settings as well as the room. Channel tuning should be done in this input or with an external RTA.</p>
<b>RTA Options</b>	See 4.4.3.2 <i>RTA Options</i> , page 58.
<b>Level/Bass/Treble adjustments</b>	<p>Touch the Level, Bass, or Treble bar, which becomes highlighted, then adjust it up or down using the Volume Control knob. These adjustments apply to the same channel as the <b>EQ ch</b>, as shown by the text on the left side of the third octave adjustments.</p> <ul style="list-style-type: none"> <li>▪ <b>Level</b> – Adjusts the output signal level from -20dB to +10dB in increments of 0.5dB.</li> <li>▪ <b>Bass</b> – Bass adjustment from -6dB to +6dB in increments of 0.1 dB. The corner frequency for the bass control is shown at left of the adjustment bar.</li> <li>▪ <b>Treble</b> – Treble adjustment from -6dB to +6dB in increments of 0.1 dB. The corner frequency for the treble control is shown at left of the adjustment bar.</li> <li>▪ <b>Corner Frequency</b> adjustments – Touch the corner frequency box for treble or bass and adjust using the Volume Control knob. The corner <b>frequency</b> for bass can be set from 50Hz to 300Hz. The corner frequency for the treble can be set from 1.5kHz to 12kHz. The corner frequency cannot be set for individual channels—the setting affects all channels in the current EQ set.</li> </ul>
<b>Levels</b>	See 4.4.6 <i>Audio Levels</i> , page 62.
<b>Copy EQ</b>	See 4.4.5 <i>Copy/Clear EQ</i> , page 61.

#### 4.4.3.1 Channel Number Selection



Figure 36. Channel Number Selection Screen

Touch the **Chan** button to bring up a display of all sixteen channels. Select the channel you would like to equalize. You may also select the next channel by touching the **+** sign button to the right of the Chan button, or select the previous channel by touching the **-** sign button left of the Chan button.

A channel selection button color will be blue if that channel has a non-flat configuration.

#### 4.4.3.2 RTA Options

RTA Options is a global setting that is used for RTA configuration in both 1/3 Octave Equalization and Parametric Equalization.

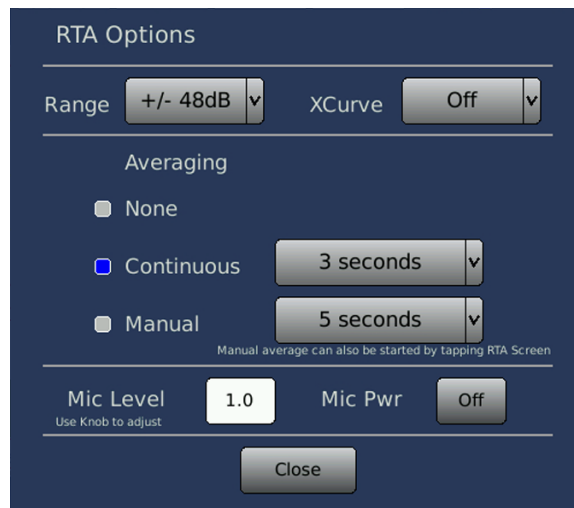

Figure 37. RTA Options Screen

Settings on this screen are described in this table.

**Table 17. RTA Options**

<b>Setting</b>	<b>Description</b>
<b>Range</b>	<p>Select a range for the RTA. Touch to open the drop down list, then use the Volume Control knob to select. Choices are +/- 3, 4, 12, 24, 48, or 64dB.</p> <p><b>Note:</b> A shortcut is provided to cycle through the range settings by tapping on the scale indication on the left side of the RTA display.</p>
<b>XCurve</b>	<p>The X Curve shows the affects of pink noise measured in larger rooms.</p> <p><b>Display</b> – adds the XCurve on the RTA display area.</p> <p><b>Offset</b> – adjusts the RTA measurement to compensate for the X-Curve.</p> <p><b>Note:</b> This should be set to <b>Off</b> for all instances, with the possible exception of when you are looking at large room response through the Mic Input.</p>
<b>Averaging</b>	<p><b>None</b> – No averaging is done on the RTA.</p> <p><b>Continuous</b> – The window period may be set to 1, 3, 5, 10, 20 or 30 seconds. The RTA displays a continuous average of measurements over a time window set by the list box on the right.</p> <p><b>Manual</b> – The window period may be set to 5, 10, 20 or 30 seconds. The RTA displays an average of measurements over a time window set by the list box on the right. The time window starts when Manual is selected. Once the time expires, the RTA display does not change. The manual average can be restarted by tapping on the RTA display.</p>
<b>Mic Level</b>	<p>Use the Volume Control knob to change the microphone input level.</p> <p><b>Mic Pwr On/Off</b> – when <b>ON</b> phantom power is applied to the microphone input connection.</p> <p><b>Note:</b> If Mic Power is ON, it remains ON when you leave this screen and go to other screens. However, Mic Power is automatically disabled when the RS20i resets. This Mic Power setting is independent of the Mic power configuration option for the Input Source.</p>

### 4.4.4 Parametric Equalization

Parametric EQ allows you to adjust the three (per channel) 20Hz to 200Hz parametric filters.

Setup > EQs > Paramtc

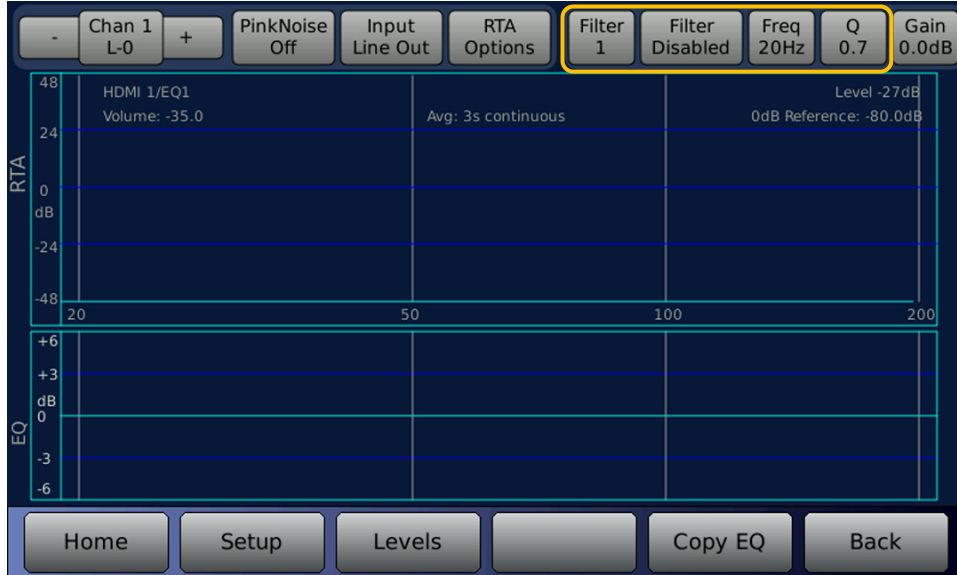

Figure 38. Parametric EQ Screen

The three filters can be configured regarding Q, Gain and Frequency, and are either enabled or disabled. Functions on this screen are described in this table.

Table 18. Parametric EQ

Function	Description
<b>Channel Number</b>	Touch the Chan button to open a popup window with selection buttons for all sixteen channels. The channel selection button color will be blue if that channel has a non-flat configuration.  Select the channel you would like to equalize. You may also select the next channel by touching the + sign button to the right of the Chan button, or select the previous channel by touching the - sign button left of the Chan button. See 4.4.3.1 <i>Channel Number Selection</i> , page 58.
<b>Pink Noise On/Off</b>	Turns Pink Noise on or off.
<b>Input LineIn/LineOut/ Mic</b>	<b>LineIn</b> means that the signal source for the RTA is from the current input channel and does not have any processing (Dirac, EQ, etc). <b>LineOut</b> means that the signal source for the RTA is from the current output channel, so you would see the effects of the Dirac, EQ, etc. If you are using the internal RTA to check the room tune, then you would select <b>Mic</b> .  <b>Note:</b> When the Input field is <b>LineIn</b> , the RTA selects the input channel. The controls for EQ, bass, treble, and trim represent what is applied to the input channel and their effects will not show up on the RTA display.  When the input field is set to <b>Mic</b> , the RTA selects the Mic input which will show the effects of the EQ settings as well as the room. Channel tuning should be

Function	Description
	done in this input or with an external RTA.
<b>RTA Options</b>	See 4.4.3.2 <i>RTA Options</i> , page 58.
<b>Filter</b>	Rotate the Volume Control knob to select from the three filters.
<b>Filter Enabled/Disabled</b>	Touch the button to enable or disable the currently selected filter.
<b>Freq</b>	Filter frequency. Rotate the Volume Control knob to adjust from 20Hz to 200Hz.
<b>Q</b>	Filter Q. Rotate the Volume Control knob to adjust from 0.7 to 5.0.
<b>Gain</b>	Filter gain. Rotate the Volume Control knob to adjust from -6.0 to +6.0.

#### 4.4.4.1 About Parametric EQ

Parametric filters allow you to adjust not only the gain or cut, but also the center frequency, and how wide or narrow the filter is. This allows you to tune in on room modes that show up in a spectrum analysis. Parametric filters allow you to add subjective bumps or dips to the filter.

The RS20i features Parametric EQ on every channel. Parametric EQ is an optional adjustment and is in addition to 1/3 Octave EQ. It is only available with low frequencies and offers more control than 1/3 Octave EQ. The Parametric EQ screen looks similar to the 1/3 Octave EQ screen but displays a frequency range from 20 to 200Hz only.

### 4.4.5 Copy/Clear EQ

Text and controls shown on the right side of this screen are dependent on the option selected on the left side of the screen.

**Copy EQ Settings** (1/3 octave EQ bass, treble, and parametric filters) from one channel to another channel. Select the channel you wish to copy from by selecting it from the drop down list. Then, select the destination channel from the **To Channel** drop down list. Press the **Copy** button to complete the process, or press **Cancel** to quit.

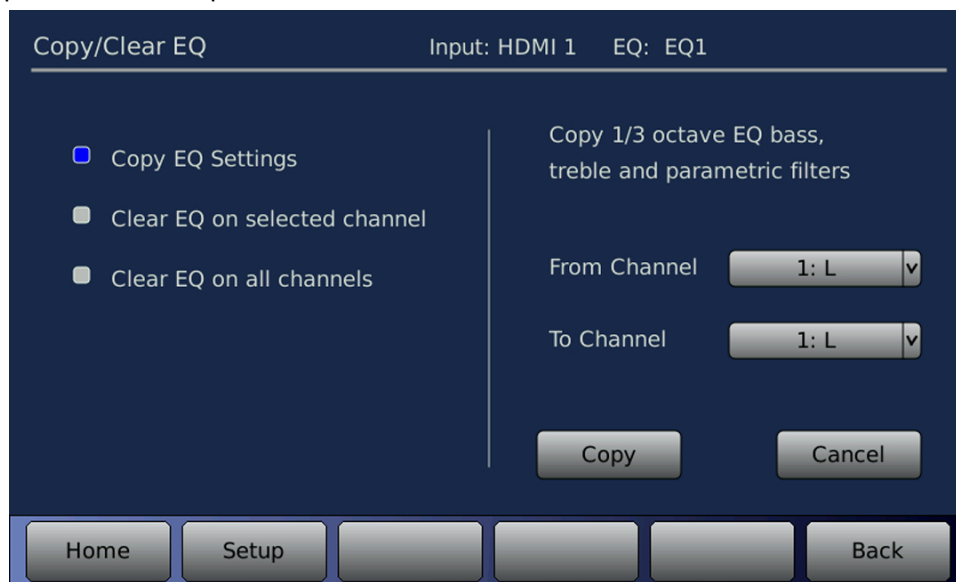

Figure 39. Copy EQ Settings

**Clear EQ on selected channel** includes two check boxes to enable which settings are included in the clear function (1) third octave EQ including bass and treble and/or (2) parametric filters. The text on the right will reflect the selection on the left. Select the channel using the drop down list, then touch **Clear** to complete the process.

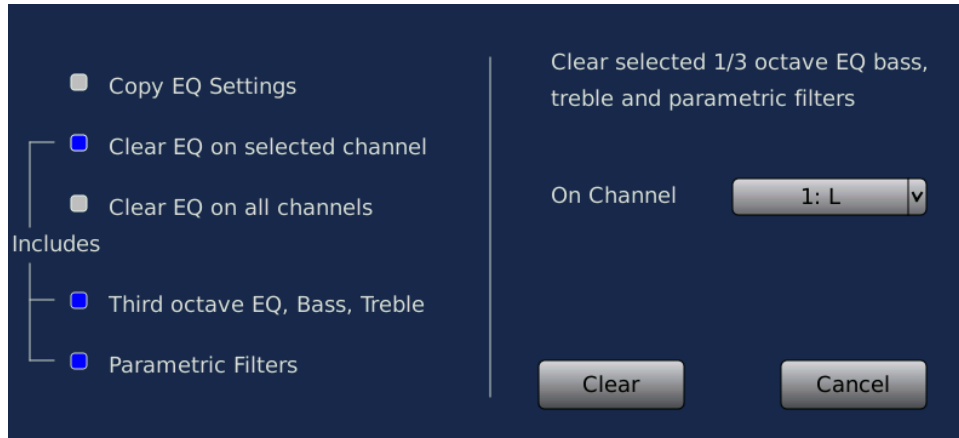

Figure 40. Clear EQ on selected channel

**Clear EQ on all channels** clears third octave, bass, treble and parametric filters on all channels.

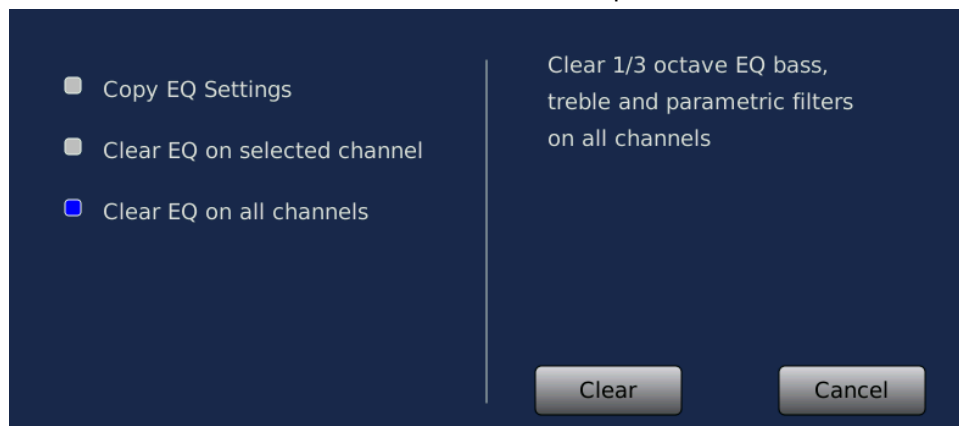

Figure 41. Clear EQ on all channels

### 4.4.6 Audio Levels

The Audio Levels screen is used for these functions:

- **Set channel levels.** Turn on the pink noise on any single channel to check and adjust the level. With Master Volume control set to -15dB the output on each speaker should be 85dBC when using an SPL meter.
- **Check channel phase.** To do this, enable pink noise on more than one channel and check the difference in sound level with an SPL meter or RTA.
- **General testing or troubleshooting.** The installer may diagnose a problem by muting selected channels while playing content, or playing pink noise on selected channels.

To access the Audio Levels screen:

**Setup > Inputs > Audio Levels**

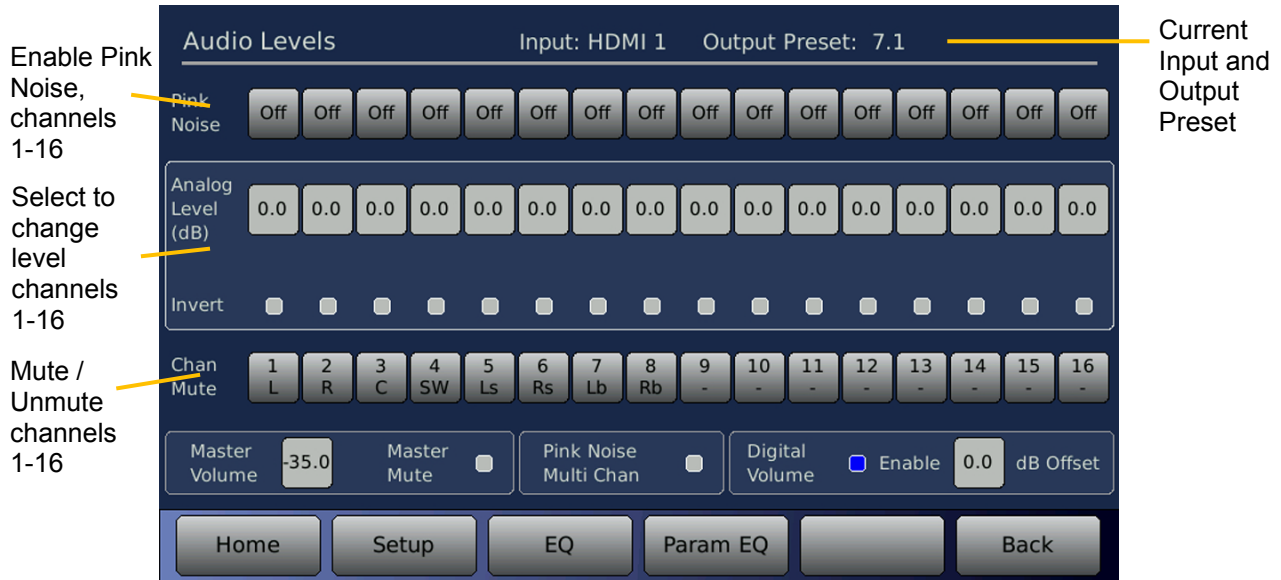

Figure 42. Audio Levels

At the top of the screen, the current **Input Preset** and current **Output Preset** are displayed.

Audio Level functions on this screen are described in this table.

**Table 19. Audio Level**

Function	Description
<b>Pink Noise</b>	Select one of the 16 buttons for channels 1 through 16 to enable pink noise for that channel. Selecting pink noise also selects the Analog Level button underneath so that level adjustments may be made just by turning the Volume Control knob. Select the same number to disable pink noise on that channel, or select another button on the same row to move the pink noise to another channel. Selecting the <b>Pink Noise Multi Chan</b> option at the bottom of the screen allows playing pink noise simultaneously on more than one channel.
<b>Analog Level</b>	Channel level -20dB to 10dB. To change, first select the control, then use the front panel Volume Control knob to adjust up or down.
<b>Invert</b>	Select control to enable/disable channel invert. Box turns blue when invert is enabled (Invert is used primarily for test purposes.)
<b>Chan Mute</b>	Select the control to mute or unmute the selected channel. Multiple channels may be muted. Channels remain mute when exiting the screen. The mute will reset after a power cycle.
<b>Master Volume</b>	Select control and use the Volume Control knob to change the master volume control setting. Normally SPL meter readings are taken with the volume control set to -15dB. This volume control is the same as the one in the Home screen.
<b>Master Mute</b>	On/off control will mute/unmute all channels. This mute enable is the same as that on the Home screen. Use it in case of accidental loud noise.

Function	Description
<b>Pink Noise Multi Chan</b>	Enabling allows multiple channels of pink noise to be chosen. When multi-channel pink noise is disabled, selecting pink noise on one channel automatically disables pink noise from the other channels.
<b>Digital Volume Enable</b>	When the Digital Volume is not Enabled, the master volume control will have no effect on the volume of the Digital Output. Once Digital Volume is Enabled, the Digital Volume Offset, which may be set from -70.0 dB to 0.0 dB, should be set to the volume control level that is considered maximum. For example, if the Digital Volume Offset is set to -15dB, then the digital signal attenuates as expected when the master volume control is set below -15dB. The digital signal volume will not increase if the volume control goes above the Digital Volume Offset.
<b>Digital Volume dB Offset</b>	Adjust by selecting it and using the Volume Control knob. The volume level is in effect only if the enable/disable box is enabled (blue).

**Note: The Pink Noise and Mute settings are temporary and not saved with the configuration.**

**Note: Channels 1 through 16 on this screen refer to the input channels. In cases where the input is routed to a different output channel, the control represents only the input channel path. The same is true if the channel is routed to more than one output in a crossover configuration. For example, if L (Ch1) is routed to output channels 1 (Left-H) and 2 (Left-L), then if Ch1 is inverted the signal will be inverted on both output channels 1 and 2.**

## 4.5 Output Preset

The Output Preset screen allows you to select and/or configure the Output Preset for the current Input Preset.

To access Output Preset Setup:



Setup > Out Prst

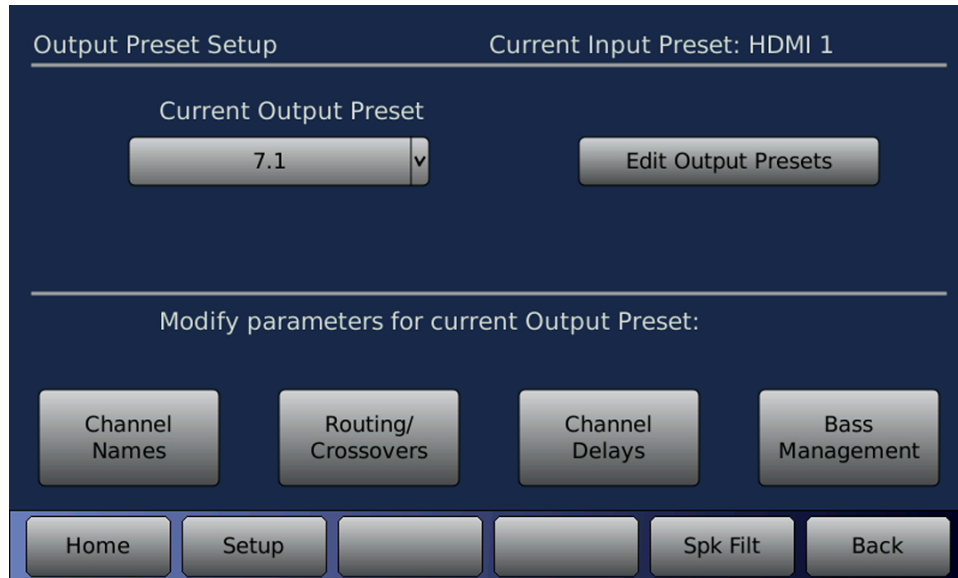

Figure 43. Output Preset Setup Screen

The Current Input Preset is displayed at the top right of the screen, so that you may verify that you are configuring the desired input. Output Preset Setup functions are described in this table.

Table 20. Output Preset Setup

Function	Description
<b>Current Output Preset</b>	The selected Output Preset for the Current Input Preset. To select a different Output Preset, open the drop-down list and select from any of the currently defined Output Presets.  Different Output Preset configurations may be used for different Input Presets (see 4.3 <i>Input Preset Screen</i> , page 38).
<b>Edit Output Presets</b>	See 4.5.1 <i>Edit Output Preset</i> , page 66. Create new presets, rename or delete existing presets.
<b>Channel Names</b>	See 4.5.2 <i>Channel Names</i> , page 68. Create or change the names for any of the 16 internal audio channels.
<b>Routing/Crossovers</b>	See 4.5.3 <i>Routing/Crossovers</i> , page 69.
<b>Channel Delays</b>	Set delays for internal (input) channels and output channels. See 4.5.4 <i>Channel Delays</i> , page 71.
<b>Bass Management</b>	Bass management balances the bass portion of the audio system based on the speaker configuration. See 4.6 <i>Bass Management Setup</i> , page 73.
<b>Spk Filt</b>	See 4.5.5 <i>Speaker</i> , page 72.

**Note: Changes made to the Channel Names, Routing/Crossovers, Channel Delays and Bass Management are saved with the Current Output Preset, and affect all Input Presets using that Output Preset.**

### 4.5.1 Edit Output Preset

The Edit Output Preset screen permits copying, renaming, and deleting Output Presets. To access this screen:

**Setup > Out Prst > Edit Output Presets**

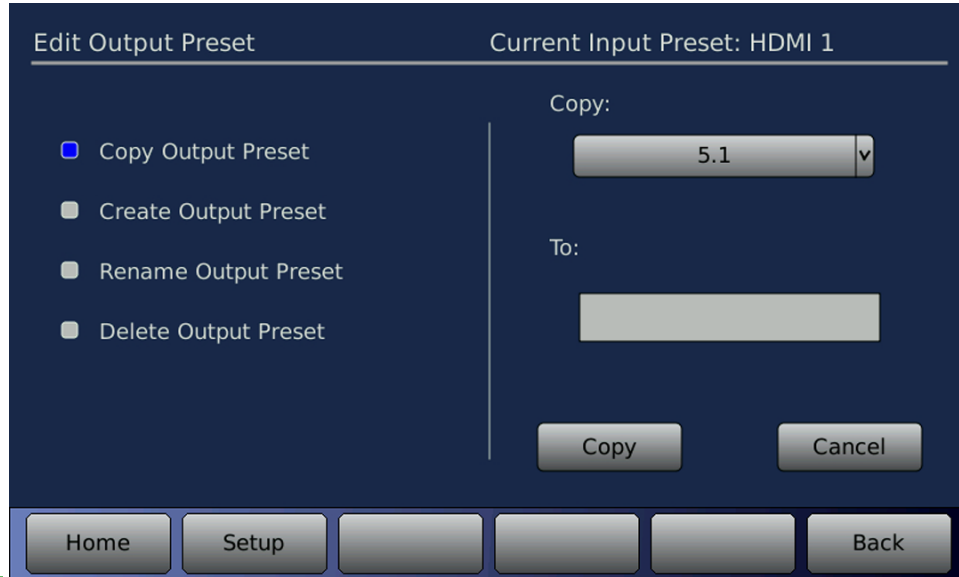

Figure 44. Output Preset Edit

The functions available on this screen are described in this table.

**Table 21. Edit Output Presets**

Function	Description
<b>Copy Output Preset</b>	<p>Copy an existing Output Preset to create a new one. See Table 22 Speaker Configurations, page 77.</p> <ul style="list-style-type: none"> <li>▪ Select the Output Preset you wish to copy from by selecting it from the <b>Copy</b> drop down list.</li> <li>▪ Then, touch the <b>To</b> box to bring up the virtual keyboard and enter a name for the new Output Preset.</li> <li>▪ Press the <b>Copy</b> button to complete the process, or press <b>Cancel</b> to quit.</li> </ul>
<b>Create Output Preset</b>	<p>Select an Output Preset template to use to create a new Output Preset.</p> <ul style="list-style-type: none"> <li>▪ Select the Output Preset you wish to copy from by selecting it in the <b>Create using template</b> drop down box.</li> <li>▪ Then, touch the <b>To</b> box to bring up the virtual keyboard and enter a name for the new Output Preset.</li> <li>▪ Press the <b>Create</b> button to complete the process, or press <b>Cancel</b> to quit.</li> </ul>
<b>Rename Output Preset</b>	<p>Give an existing Output Preset a new name.</p> <ul style="list-style-type: none"> <li>▪ Select an existing Output Preset from the <b>Rename</b> drop-down list on the right side of the screen.</li> <li>▪ Touch the <b>To</b> box to bring up the virtual keyboard and enter a new name for the Output Preset.</li> </ul>

Function	Description
	<ul style="list-style-type: none"> <li>Press the <b>Rename</b> button to complete the process, or press <b>Cancel</b> to quit.</li> </ul> <p><b>Note:</b> The Output Preset name is changed for all Inputs that use the Output preset.</p>
<b>Delete Output Preset</b>	<ul style="list-style-type: none"> <li>Select an existing Output Preset from the <b>Delete</b> drop-down list on the right side of the screen.</li> <li>Press the <b>Delete</b> button to complete the process, or press <b>Cancel</b> to quit.</li> </ul>

The table below shows the speaker configuration and channel numbers assigned for the available Output Preset Templates.

**Table 22. Speaker Configurations for different Output Preset Templates**

Name	Speaker Configuration	1	2	3	4	5	6	7	8	9	10	11	12	13	14	15	16
<b>5.1</b>	<b>5.1</b>	L	R	C	SW	Ls	Rs										
<b>7.1</b>	<b>7.1</b>	L	R	C	SW	Ls	Rs	Lb	Rb								
<b>11.4</b>	<b>11.4</b>	L	R	C	Sw 1	Ls	Rs	Lb	Rb	HL	HR	Lw	Rw	Sw 2	Sw 3	Sw 4	
<b>Auro 9.1</b>	<b>Auro 9.1</b>	L	R	C	Sw 1	Ls	Rs	-	-	HL	HR	HL S	HR S	Sw 2	Sw 3	Sw 4	-
<b>Auro 11.1</b>	<b>Auro 11.1</b>	L	R	C	Sw 1	Ls	Rs	-	-	HL	HR	HL S	HR S	Sw 2	Sw 3	HC	T
<b>Auro 13.1</b>	<b>Auro 13.1</b>	L	R	C	Sw 1	Ls	Rs	Lb	Rb	HL	HR	HL S	HR S	Sw 2	Sw 3	HC	T

## 4.5.2 Channel Names

The channel names screen can be used to create or change the names for any of the 16 internal audio channels. The channel names are initially assigned by the default Output Preset. The channel names should match the internal channel definitions given by the Speaker Configuration (see Table 22, above).

The names are stored with the Output Preset in which the assignments are made.

**Note: The channel names must match the Speaker Configuration to preserve compatibility with the decoder output channels, which are fixed.**

To access the Channel Names screen:

**Setup > ChNames**

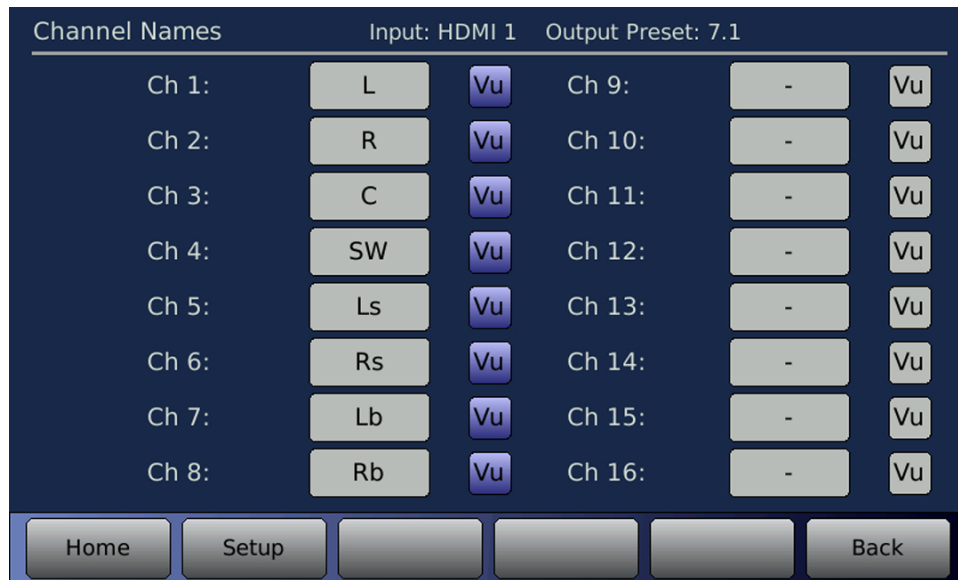

Figure 45. Assign Channel Names Screen (8-channel)

To change or enter a new channel name select the white field next to the desired channel. A keyboard will appear allowing you to enter text. Type in the channel name then select **OK**. The channel name will now appear in the field and in the Home screen.

When a **Vu** button is highlighted blue, that channel will display Vu bars on the Home screen.

The names assigned apply to the internal channel before the output routing. Output channels are identified in various RS20i screens by using the internal channel name (before routing) followed by a dash ('-') and the output channel ID. For example, if channel 1 is L and routed to output channels 1 and 9 using the channel IDs 'H' and 'L', respectively, then output channel 1 is labeled as L-H and output channel 9 is labeled L-L.

### 4.5.3 Routing/Crossovers

Setup > Routing

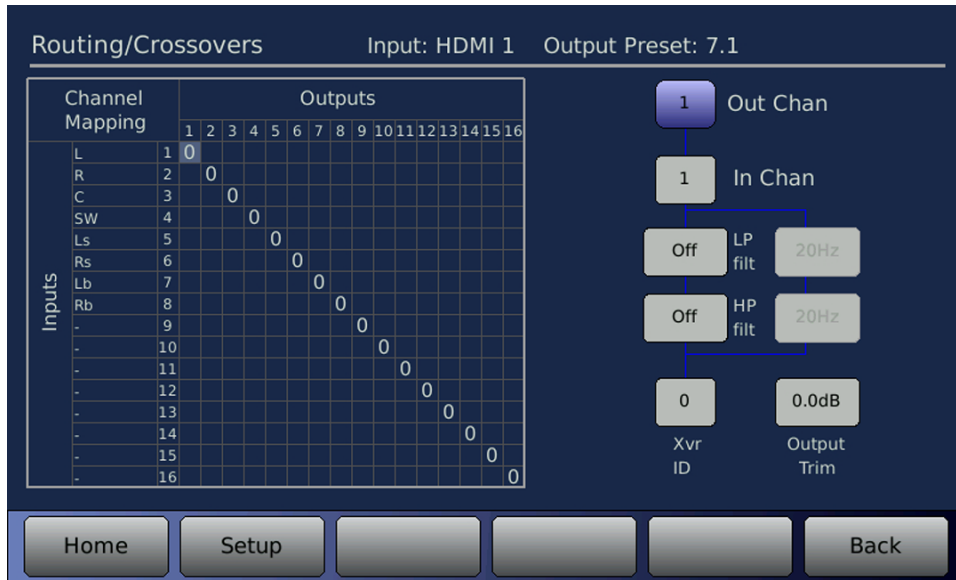

Figure 46. Crossover Setup Screen

The matrix on the left displays the input channel – to – output channel mapping.

The controls available on this screen are described in this table.

**Table 23. Routing/Crossovers**

Control	Description
<b>Out Chan</b>	Output channel selection. The configuration items below are all configured in reference to the output channel selection. Touch the field and use the Volume Control knob to change the setting.
<b>In Chan</b>	Select Input channel that routes to output channel.
<b>LP filt</b>	Low Pass Filter Options are: Off, 6, 12, 18, 24, and 48 dB/octave Butterworth, 12, 24, and 48 Linkwitz-Riley, and 6, 12, 18, 24, and 48 dB/octave Bessel.  Frequency: 20 Hz to 20kHz
<b>HP filt</b>	High Pass Filter Options are: Off, 6, 12, 18, 24, and 48 dB/octave Butterworth, 12, 24, and 48 Linkwitz-Riley, and 6, 12, 18, 24, and 48 dB/octave Bessel

Control	Description
	Frequency: 20 Hz to 20kHz
Xvr ID	Output Channel ID: 0-8,L,M,H,W
Output Trim	Output Channel Trim (-10.0 dB to 0.0 dB in .5dB increments)  The Output Trim may be used to balance the levels of crossover channels.

**Note: The output channels are assigned one of the following letter IDs (Crossover ID): W, L, M, H, and 0-9. This is used for reference for the output channel and has no functional purpose at this time.**

#### 4.5.3.1 About Routing Crossovers

Crossover use can be attributed to the inability of most speaker drivers to reproduce the entire audio spectrum smoothly and efficiently. Because of this, most speaker systems are comprised of several drivers, each of which is dedicated to the reproduction of a specific range of frequencies.

These frequencies are routed to the appropriate driver by a crossover network. This device divides the audio spectrum into two or more frequency bands. By doing this, each driver will receive only the frequencies that it can reproduce properly. The crossover network also prevents potentially damaging low-frequency energy from reaching the midrange or tweeter drivers.

This frequency division process is accomplished by using high-pass and low-pass filters. A high-pass filter passes frequencies above a pre-determined frequency and attenuates those below. This pre-determined frequency is called the crossover point. Conversely, a low-pass filter passes frequencies below the crossover point and attenuates those above. By cascading high-pass and low-pass filters, a band-pass filter can be realized. Filters of this type attenuate all frequencies outside of the pass-band created by the high and low-pass filters.

The rate at which the attenuating process takes place is dependent upon the slope of the crossover. A typical slope for sound systems is 24dB/octave. Higher numbers indicate a much steeper cutoff rate while the lower numbers indicate a more gradual roll-off.

#### 4.5.3.2 Signal flow

When implementing crossovers or implementing different internal routing on the RS20i, the internal channel numbers do not match the output channel numbers. The following explanation clarifies how the menus operate regarding the channel numbers.

From a user perspective, the channel mapping occurs near the last stage of the signal processing. Only high pass and low pass filters are applied after the signal routing occurs. This is illustrated in the diagram below.

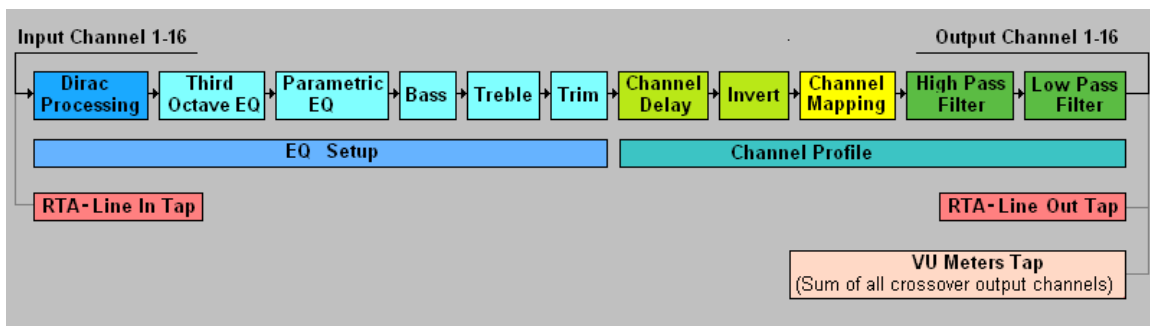

Figure 47. Signal Processing Flow Diagram

Vu meters on the Home screen show the input channel name while showing the Vu level of the sum of the outputs for that crossover channel.

### 4.5.3.3 High Pass and Low Pass Shelf

The High Pass and Low Pass Shelves are for active crossover systems. The High Pass is the portion of the sound spectrum that is going to find its way to the top-end compression driver. The Low Pass is the portion of the sound spectrum that is going to find its way to the mid-woofer.

Since there are 16 output channels available, you have the option to use them any way you like. Suppose you actually have six channels of incoming sound, then you have 10 other D/A converted outputs that can be used as crossovers. All you need to do is identify which channels will be used as crossovers. Setting up your system in this way, lets you do away with passive crossovers. Although you would need more amplifiers, it does give you much tighter control of your system.

You can also decide how steep the High Pass or Low Pass cut-off is. The conventional values are 6, 12, 18, and 24 dB. As the numbers go up, the cut-off is steeper.

**Note: Set up the crossovers before you run the Dirac software. The Dirac software will fine-tune the characteristics of the crossover point. If a driver has issues with time alignment, or encounters an aberration of some sort that can be measured, it will do its best to correct for it. It will also adjust all the amplitudes to their appropriate values to get a smooth response within that range.**

## 4.5.4 Channel Delays

The Channel Delays screen is used to set delays for internal (input) channels and output channels. The channel delays settings are saved with the current Output Preset.

### Setup > ChDelays

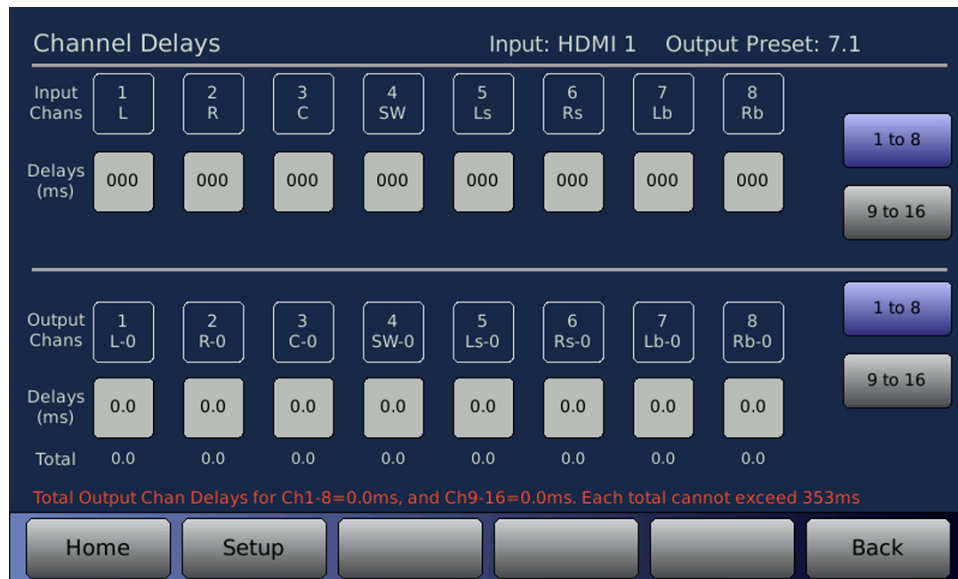

Figure 48. Channel Delays

The upper portion is used to set the delay for the Input Channels. The right portion has a button to select between channels 1 to 8 or channels 9 to 16. The lower portion sets delays for Output Channels. The total delay for a group of output channels cannot exceed 353ms.

The controls available on this screen are described in this table.

**Table 24. Channel Delays**

Control	Description
<b>Input Chans</b>	Input channel delay (0 to 999 ms)
<b>Output Chans</b>	Output channel delay (0.0 to 120.0 ms)
<b>Delays</b>	Touch the Delays box under the desired input channel. Enter the delay by dialing in the correct value using the front panel Volume Control knob.
<b>1 to 8 9 to 16</b>	These buttons control the range of channels displayed in the upper and lower portions.

**Note: The channels groups used to calculate the maximum output delay are grouped with channels 1-12, and channels 13-16.**

The Input delay occurs before the routing. Input Delays should be used for time-aligning sound from different channels at the listening position. The Output delay occurs after the routing and its use should be limited to adjusting delays in cases where a channel is routed to more than one speaker. Examples of this are a) crossover outputs and b) surround arrays.

### 4.5.5 Speaker Filter

This screen is used to define up to 9 parametric filters for each channel, to flatten a speaker response. Unlike the EQ settings, these filter configurations are stored with the Output Profile.

**Setup > Out Prst > Spk Filt**

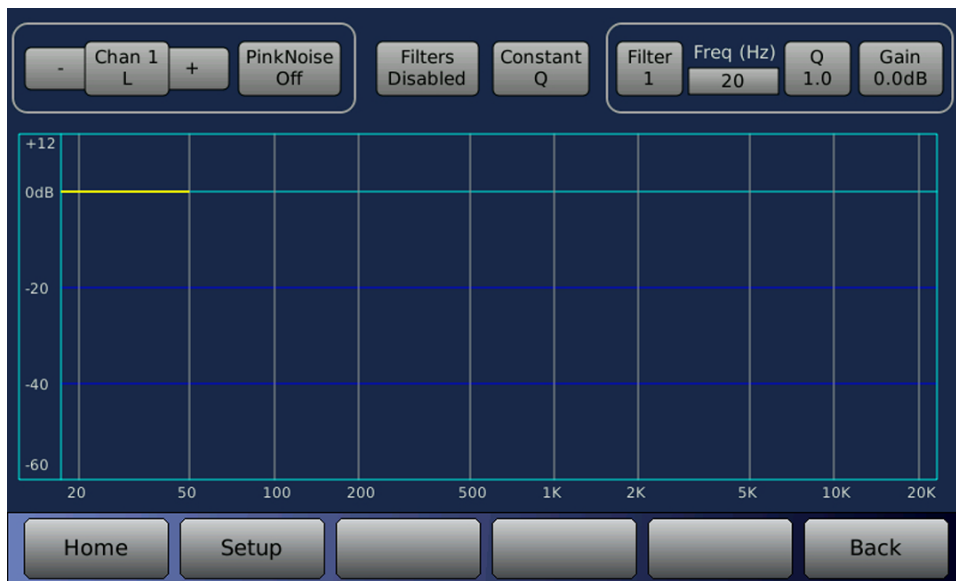

Figure 49. Speaker Filter

The controls available on this screen are described in this table.



**Table 25. Speaker Filter**

<b>Control</b>	<b>Description</b>
<b>Chan nn</b> - +	Channel selection - previous channel + next channel
<b>Pink Noise On/Off</b>	Channel pink noise.
<b>Filters Enabled/Disabled</b>	Enable or Disable all PEQ filters for all channels.
<b>Constant Q/BW</b>	Constant Q or constant bandwidth.
<b>Filter 1-9</b>	Select filter 1 to 9 to set the filter parameters.
<b>Freq (Hz)</b>	Filter Frequency: 20Hz to 20kHz.
<b>Q</b>	Filter Q: 0.1 to 10.0.
<b>Gain</b>	Filter Gain: -60dB to 12.0dB.

## 4.6 Bass Management Setup

This section describes how to configure the bass management on the RS20i using the Setup screens. This assumes that you are familiar with the RS20i bass management features and concepts. If not, you are encouraged to review topic 4.7.3, Bass Management Theory (page 83) before proceeding with the setup.

The Bass Management configuration, including the Speaker Configuration, is contained within an Output Preset configuration of the RS20i. The configuration changes made in this screen are applied to the currently selected Output Preset. Separate Output Presets can be made with different Bass Management and Speaker Configuration settings.

Bass management balances the bass portion of the audio system based on the speaker configuration. Sub-bass configurations vary from none up to 4 subwoofers.

To access Bass Management Setup:

**Setup > Output Prst > BassMan**



Figure 50. Bass Management Setup Screen

The screen above shows all available speakers for the selected Speaker Configuration.

**Table 26. Bass Management Setup Screen**

Controls	Description
<b>Speaker Configuration</b>	Select speaker configuration that matches the installation. Only the speakers available for the chosen configuration will be active for setup. Unavailable speakers will be disabled and grayed out on the screen.
<b>Subwoofer Configuration</b>	Select number and positions for subwoofers. See Subwoofer Configuration Options table, below.
<b>Enable Bass Management</b>	On/Off— Enable all bass management functions.
<b>Full Range to Subs</b>	On/Off – Select to remove all low pass filters to the subwoofers.
<b>Speaker icons</b>	Touch an icon to open a speaker setup screen. L/R – Left/Right speakers C – Center speaker Ls/Rs – Left/Right Surround speakers Lb/Rb – Left/Right Back speakers HL/HR – High Left / High Right speakers Lw/Rw – Front Wide speakers HLs/HRs – High Surround speakers HC – High Center speaker T – Top Center speaker

## Subwoofer Configuration

The subwoofer configuration option configures the bass management with the number of sub-woofer channels between 0 and 4.

**Table 27. Subwoofer Configuration Options**

Subwoofer Configuration Options	Number of Subwoofers	Subwoofer Channel Assignments
No Subs	0	None
Mono	1 to 4	Ch4, Ch13, Ch14, Ch15
LFront/RFront	2	Ch4 - Left Front Ch13 - Right Front
Front/Back	2	Ch4 - Front Ch13 - Back
LFront/RFront/Back	3	Ch4 - Left Front Ch13 - Right Front Ch14 - Back
LFront/RFront LBack/RBack	4	Ch4 - Left Front Ch13 - Right Front Ch14 - Left Back Ch15 - Right Back <b>Note:</b> This option is not available for speaker configurations with HC (Auro11.1 or Auro13.1).

### 4.6.1 Speaker Options Configuration Screen

Each speaker or speaker pair can be individually configured in Bass Management by selecting the speaker icon on the Bass Management screen.

Any Left/Right paired speakers share the same settings, so the configuration needs to be set only on one of the two. For example, when the Left Front speaker is configured, the Right Front speaker will use that configuration. Speaker pairs that share configurations are L/R, Ls/Rs, Lb/Rb, HL/HR, HLs/HRs, Lb/Rb, and Lw/Rw.

Each speaker or speaker pair may display a different set of options. Figure 51 shows Bass Management Center Speaker Options for a configuration with Subwoofers. Touch the icon of the Center Speaker, in the Bass Management Setup screen, to access this screen.

**Setup > Output Prst > BassMan > Center**

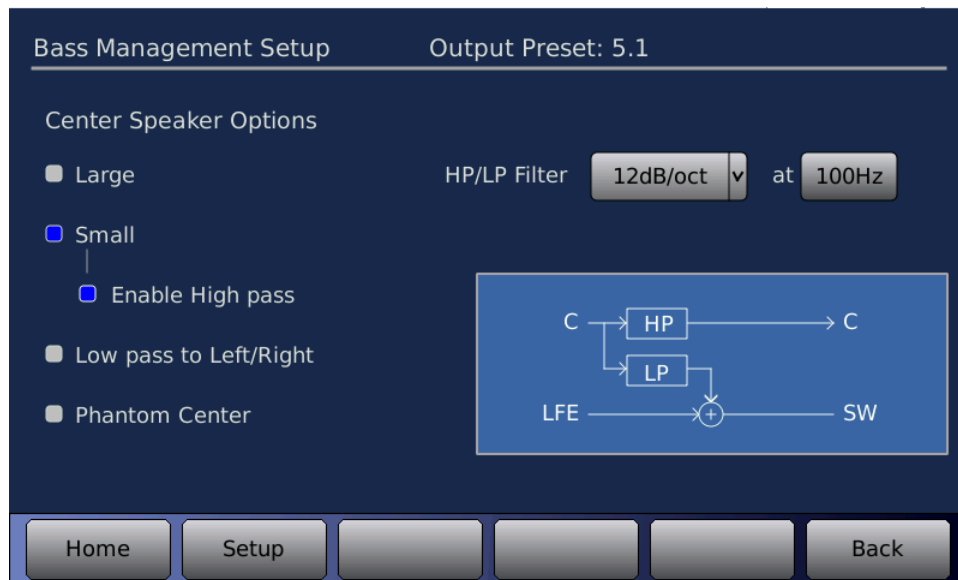

Figure 51. Bass Management Center Speaker Options

Options differ for other speakers, and the speaker function may change if there are no subwoofers. Please refer to the tables in this section for options available depending on speaker.

- Table 28. Speaker Options using one or more Subwoofers
- Table 29. Speaker Options using no subwoofers

### HP/LP Filter

This configures the high pass and low pass filters when Small speaker option is selected, as shown in Figure 51, above. The slope can be set at either 12dB/octave or 24dB/octave. The cutoff frequency can be set between 31Hz and 160Hz. The HP and LP both use the same slope and frequency.

**Note: If the bass management option for full range to subs is selected, then there is no low pass filter. All frequencies in the signal are sent to the sub.**

### Offset

The offset control appears when the phantom speaker option is selected. It allows the level for that speaker to be adjusted before being mixed with another speaker. The offset level can be adjusted from +3dB to -10dB.

### Bass Management Options for Speakers

Table 28 shows the possible types of speaker configuration options available when the speaker configuration includes one or more subwoofers.

**Table 28. Speaker Option with One or More Subwoofers**







Controls	Applicable Channels	Diagram (replace center with applicable channel)	Description
Large	All		No modifications to channel
Small, Enable High Pass	All		Crossed with LFE High pass on channel audio Low pass to LFE
Small, High Pass Not Enabled	Center, Left/Right		Channel audio is crossed with LFE Low pass to LFE
Small, cross to (other speaker)	Depends on speaker: C cross to L/R Ls/Rs cross to L/R Lb/Rb cross to L/R HL/HR cross to L/R HC cross to C HLs/HRs cross to Ls/Rs T cross to L/R/LS/RS		When this option is used, the "other" speaker <u>must be large</u> . If it is not, there will be an error message in <b>red text</b> displayed below the diagram on the screen.
Phantom Center	Center		Center channel offset and mixed with Left and Right channels.
Phantom Surround	Left Surround/ Right Surround		Left Surround offset and mixed with Left channel, Right Surround offset and mixed with the Right channel.

Table 29 shows the possible types of speaker configuration options available when the speaker configuration includes no subwoofer.

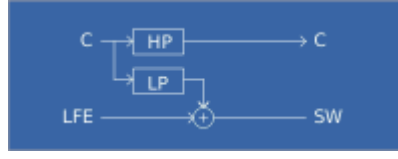
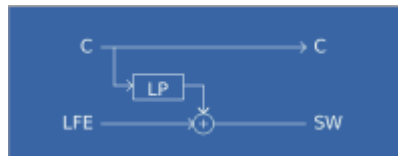
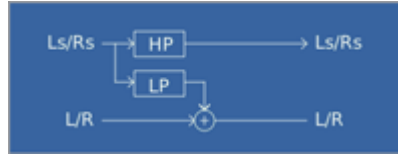
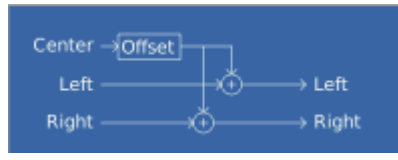
**Table 29. Speaker Options with No Subwoofers**

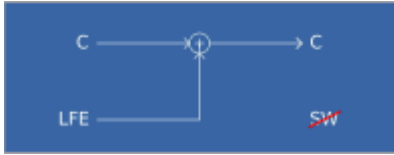
Controls	Applicable Channels	Diagram (replace center with applicable channel)	Description
Large	All	<p>For L/R and Ls/Rs:</p>  <p>For other speakers:</p> 	For L/R and/or Ls/Rs: the LFE signal will be added to those speakers.
Small, Enable High Pass	All		No LFE added to audio channel High pass on channel
Small, High Pass Not Enabled	Center, Left/Right		No LFE added to channel
Small, cross to (other speaker)	Depends on speaker: C cross to L/R Ls/Rs cross to L/R Lb/Rb cross to L/R HL/HR cross to L/R HC cross to C HLs/HRs cross to Ls/Rs T cross to L/R/LS/RS		When this option is used, the "other" speaker <u>must be large</u> . If it is not, there will be an error message in <b>red text</b> displayed below the diagram on the screen.
Phantom Center	Center		Center channel offset and mixed with Left and Right channels.
Phantom Surround	Left Surround/ Right Surround		Left Surround offset and mixed with Left channel, Right Surround offset and mixed with the Right channel.

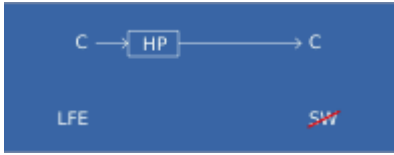
## 4.7 Bass Management Setup Procedure

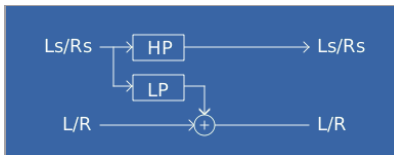
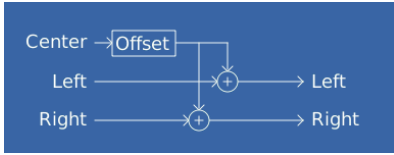
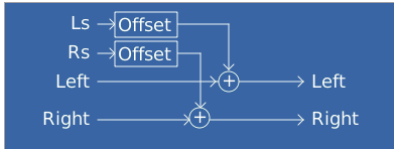
The Bass Management screen is where you set the speaker configuration.

To access the Base Management screen, press:

**Setup > Output Prst > BassMan.**

Select the **Speaker Configuration** (that matches your installation) from the drop down on the Bass Management Setup screen. The channel definitions for each speaker configuration are given in Table 30.

**Table 30. Bass Management Speaker Configuration**

Speaker Configuration	Channels															
	1	2	3	4	5	6	7	8	9	10	11	12	13	14	15	16
2.0	L	R														
2.1	L	R		Sw1								Sw2	Sw3	Sw4		
3.1	L	R	C	Sw1								Sw2	Sw3	Sw4		
4.1	L	R		Sw1	Ls	Rs						Sw2	Sw3	Sw4		
5.1	L	R	C	Sw1	Ls	Rs						Sw2	Sw3	Sw4		
7.1 h	L	R	C	Sw1	Ls	Rs			HL	HR			Sw2	Sw3	Sw4	
7.1w	L	R	C	Sw1	Ls	Rs					Lw	Rw	Sw2	Sw3	Sw4	
9.1hw	L	R	C	Sw1	Ls	Rs			HL	HR	Lw	Rw	Sw2	Sw3	Sw4	
7.1	L	R	C	Sw1	Ls	Rs	Lb	Rb					Sw2	Sw3	Sw4	
9.1h	L	R	C	Sw1	Ls	Rs	Lb	Rb	HL	HR			Sw2	Sw3	Sw4	
9.1w	L	R	C	Sw1	Ls	Rs	Lb	Rb			Lw	Rw	Sw2	Sw3	Sw4	
11.1 hw	L	R	C	Sw1	Ls	Rs	Lb	Rb	HL	HR	Lw	Rw	Sw2	Sw3	Sw4	
Auro 9.1	L	R	C	Sw1	Ls	Rs			HL	HR	HLs	HRs	Sw2	Sw3	Sw4	
Auro 10.1	L	R	C	Sw1	Ls	Rs			HL	HR	HLs	HRs	Sw2	Sw3	Sw4	T
Auro 11.1	L	R	C	Sw1	Ls	Rs			HL	HR	HLs	HRs	Sw2	Sw3	HC	T
Auro 11.1 (7+4)	L	R	C	Sw1	Ls	Rs	Lb	Rb	HL	HR	HLs	HRs	Sw2	Sw3	Sw4	
Auro 13.1*	L	R	C	Sw1	Ls	Rs	Lb	Rb	HL	HR	HLs	HRs	Sw2	Sw3	HC	T

\*Note: When Auro 13.1 is selected, a checkbox labeled “Phantom HC” appears on the Bass Management screen, for selecting a 13.1 configuration without the HC speaker. When selected, the HC channel is downmixed with HL and HR.

Activate **Enable Bass Management** on the Bass Management Setup screen. This is the master enable that turns on all Bass Management functions.

Select the subwoofer configuration with the appropriate number and position of the subwoofers used. The channel assignments for the selected subwoofer configuration are listed on the screen when selecting one or more subwoofers.

**Skip to page 81 to setup bass management for a configuration with no subwoofers.**

### 4.7.1 Configuration using 1 or more subwoofers

Select Full-Range to Subs only if you wish to omit the Low Pass filter for all channels crossed to the subwoofer.

For steps 2 through 10, tap on the speaker below its label and set the options for that speaker. Skip any speakers that do not apply to the current speaker configuration. Use the Back button to return to the main Bass Management screen to select the next speaker. Those speakers that are not used will be grayed out and cannot be selected.

#### C – Center speaker Options:

- **Large** – (default) Speaker can handle full range of frequencies.
- **Small** – Cross with the subwoofer(s). Select the desired crossover filter frequency and slope. The high-pass filter to the Center speaker may be disabled if desired.
- **Low Pass to Left/Right** – Cross the center channel to the Left and Right Front speakers. Adjust the crossover frequency and slope as needed.
- **Phantom Center** – Use this if there is no center speaker installed. This divides the center channel between the left and right speakers. The offset can be adjusted. **Note:** when this is selected, the speaker is grayed out on the main Bass Management screen.

#### L, R – Left and Right speaker options:

- **Large** – (default) Speaker can handle full range of frequencies.
- **Small** – Cross with the subwoofer(s). Select the desired crossover filter frequency and slope. The high-pass filter to the Left and Right speaker may be disabled if desired.

#### Ls, Rs – Left Surround and Right Surround speaker options:

- **Large** – (default) Speaker can handle full range of frequencies.
- **Small** – Cross with the subwoofer(s). Select the desired crossover filter frequency and slope.
- **Small, cross to L/R** – The Left Surround will be crossed to the Left Front speaker and Right Surround will be crossed to the Right Front speaker. Select the desired crossover filter frequency and slope. In order to use this option, the Left and Right Front speakers should be defined as Large. If not, an error message will appear on the screen.
- **Phantom Surround** – Use this if Left and Right Surround speakers are not installed. The Left Surround channel is mixed with the Left Front speaker and the Right Surround channel is mixed with the Right Front speaker. The offset can be adjusted.

#### Lb, Rb – Left Back and Right Back speaker options:

- **Large** – (default) Speaker can handle full range of frequencies.
- **Small** – Cross with the subwoofer(s). Select the desired crossover filter frequency and slope.
- **Small, cross to L/R** – The Left Back will be crossed to the Left Front speaker and Right Back will be crossed to the Right Front speaker. Select the desired crossover filter frequency and slope. In order to use this option, the Left and Right Front speakers should be defined as Large. If not, an error message will appear on the screen.

#### Lw, Rw – Left Wide and Right Wide speaker options:

- **Large** – (default) Speaker can handle full range of frequencies.
- **Small** – Cross with the subwoofer(s). Select the desired crossover filter frequency and slope.

#### HL, HR – High Left and High Right speaker options:

- **Large** – (default) Speaker can handle full range of frequencies.



- **Small** – Cross with the subwoofer(s). Select the desired crossover filter frequency and slope.
- **Small, cross to L/R** – The High Left will be crossed to the Left Front speaker and High Right will be crossed to the Right Front speaker. Select the desired crossover filter frequency and slope. In order to use this option, the Left and Right Front speakers should be defined as Large. If not, an error message will appear on the screen.

#### HC – High Center speaker options:

- **Large** – (default) Speaker can handle full range of frequencies.
- **Small** – Cross with the subwoofer(s). Select the desired crossover filter frequency and slope.
- **Small, cross to C** – The High Center will be crossed to the Center speaker. Select the desired crossover filter frequency and slope. In order to use this option, the Center speaker should be defined as Large. If not, an error message will appear on the screen.

#### HLs, HRs – High Left Surround and High Right Surround speaker options:

- **Large** – (default) Speaker can handle full range of frequencies.
- **Small** – Cross with the subwoofer(s). Select the desired crossover filter frequency and slope.
- **Small, cross to Ls/Rs** – The High Left Surround will be crossed to the Left Surround speaker and High Right Surround will be crossed to the Right Surround speaker. Select the desired crossover filter frequency and slope. In order to use this option, the Left Surround and Right Surround speakers should be defined as Large. If not, an error message will appear on the screen.

#### T – Top speaker options:

- **Large** – (default) Speaker can handle full range of frequencies.
- **Small** – Cross with the subwoofer(s). Select the desired crossover filter frequency and slope.
- **Cross to L/R/Ls/Rs** – Top speaker will be crossed with the Left Front, Right Front, Left Surround, and Right Surround speakers. In order to use this option, the L, R, LS, and Rs speakers should be defined as Large. If not, an error message will appear on the screen.

All speaker configuration options are described in text next to the speaker. This completes the bass management setup using one or more subwoofers.

## 4.7.2 Configuration with no subwoofers

For the following steps, tap on the speaker below its label and set the options for that speaker. Skip any speakers that do not apply to the current speaker configuration. Use the Back button to return to the main Bass Management screen to select the next speaker. Those speakers that are not used will be grayed out and cannot be selected.

#### C – Center speaker Options:

- **Large** – (default) Speaker can handle full range of frequencies.
- **Small** – Apply high pass filter to Center channel. Select the desired filter frequency and slope. The high-pass filter to the Center speaker may be disabled, in which case it works the same as using the option Large.
- **Low Pass to Left/Right** – Cross the center channel to the Left and Right Front speakers. Adjust the crossover frequency and slope as needed.
- **Phantom Center** – Use this if there is no center speaker installed. This divides the center channel between the left and right speakers. The offset can be adjusted. **Note:** when this is selected, the speaker is grayed out on the main Bass Management screen.

#### L, R – Left and Right speaker options:

- **Large** – (default) Mix LFE channel with this speaker.
- **Small** – Do not mix LFE channel with this speaker. A high pass filter is applied to the Left Surround and Right Surround channels. Adjust the high pass frequency and slope as needed.

**Ls, Rs – Left Surround and Right Surround speaker options:**

- **Large** – (default) Mix LFE channel with this speaker.
- **Small** – Do not mix LFE channel with this speaker. A high pass filter is applied to the Left Surround and Right Surround channels. Adjust the high pass frequency and slope as needed.
- **Small, cross to L/R** – The Left Surround will be crossed to the Left Front speaker and Right Surround will be crossed to the Right Front speaker. Select the desired crossover filter frequency and slope. In order to use this option, the Left and Right Front speakers should be defined as Large. If not, an error message will appear on the screen.
- **Phantom Surround**. Use this if Left and Right Surround speakers are not installed. The Left Surround channel is mixed with the Left Front speaker and the Right Surround channel is mixed with the Right Front speaker. The offset can be adjusted.

**Lb, Rb – Left Back and Right Back speaker options:**

- **Large** – (default) Speaker can handle full range of frequencies.
- **Small** – A high pass filter is applied to the Left Back and right Back channels. Adjust the high pass frequency and slope as needed.
- **Small, cross to L/R** – The Left Back will be crossed to the Left Front speaker and Right Back will be crossed to the Right Front speaker. Select the desired crossover filter frequency and slope. In order to use this option, the Left and Right Front speakers should be defined as Large. If not, an error message will appear on the screen.

**Lw, Rw – Left Wide and Right Wide speaker options:**

- **Large** – (default) Speaker can handle full range of frequencies.
- **Small** – A high pass filter is applied to the Left Wide and Right Wide channels. Adjust the high pass frequency and slope as needed.

**HL, HR – High Left and High Right speaker options:**

- **Large** – (default) select this option if the front high speakers can handle all frequencies.
- **Small** – A high pass filter is applied to the High Left and High Right channels. Adjust the high pass frequency and slope as needed.
- **Small, cross to L/R** – The High Left will be crossed to the Left Front speaker and High Right will be crossed to the Right Front speaker. Select the desired crossover filter frequency and slope. In order to use this option, the Left and Right Front speakers should be defined as Large. If not, an error message will appear on the screen.

**HC – High Center speaker options:**

- **Large** – (default) select this option if the front high speakers can handle all frequencies.
- **Small** – A high pass filter is applied to the Center channel. Adjust the high pass frequency and slope as needed.
- **Small, cross to C** – The High Center will be crossed to the Center speaker. Select the desired crossover filter frequency and slope. In order to use this option, the Center speaker should be defined as Large. If not, an error message will appear on the screen.

**HLs, HRs – High Left Surround and High Right Surround speaker options:**

- **Large** – (default) select this option if the high surround speakers can handle all frequencies.
- **Small** – A high pass filter is applied to the High Left Surround and High Right Surround channels. Adjust the high pass frequency and slope as needed.
- **Small, cross to Ls/Rs** – The High Left Surround will be crossed to the Left Surround speaker and High Right Surround will be crossed to the Right Surround speaker. Select the desired crossover filter frequency and slope. In order to use this option, the Left Surround and Right Surround speakers should be defined as Large. If not, an error message will appear on the screen.

**T – Top speaker options:**

- **Large** – (default) select this option if the Top speaker can handle all frequencies.
- **Small** – A high pass filter is applied to the Top speaker channel. Adjust the high pass frequency and slope as needed.
- **Cross to L/R/Ls/Rs** – The Top speaker will be crossed with the Left Front, Right Front, Left Surround, and Right Surround speakers. In order to use this option, the L, R, Ls, and Rs speakers should be defined as Large. If not, an error message will appear on the screen.

All speaker configuration options are described in text next to the speaker. This completes the bass management setup using no subwoofers.

### 4.7.3 Bass Management Theory

Bass management balances the bass portion of the audio system based on the speaker configuration. Sub-bass configurations vary from none up to 4 subwoofers.

#### 4.7.3.1 Crossed Speakers

Each channel may be combined with the LFE channel in order to extend the low range beyond what can be heard from the channel's speaker. The software allows you to set crossover filter frequency and slope to best match the speaker(s). The high pass and low pass filters range from 31Hz to 160Hz, and use either 12dB/octave or 24dB/octave.

The figure below illustrates how the left channel input may be divided between the left channel and the LFE channel. Each channel works in a similar fashion. The high pass filter can optionally be bypassed.

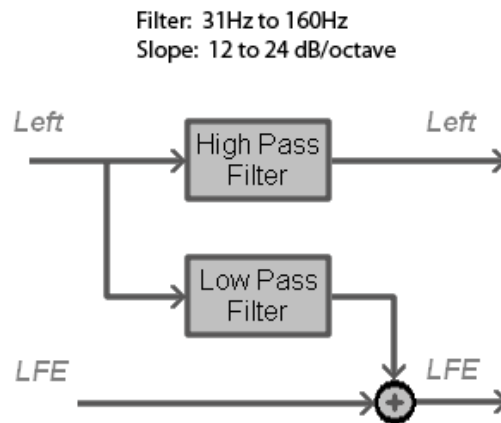

Figure 52. Dividing the Left Channel

There is one configuration for each of the channel pairs, and a separate configuration for the Center, High Center, and Top channels. Individual configurations can be made for the following speakers or speaker pairs:

- Left Front, Right Front (L/R)
- Left Wide Front and Right Wide Front (Lw/Rw)
- Center Speaker (C)
- Left Surround and Right Surround (Ls/Rs)
- Left Back Surround and Right Back Surround (Lb/Rb)
- High Left Front and High Right Front (HL/HR)
- High Center (HC)
- High Left Surround and High Right Surround (HLs/HRs)
- Top (T)

The speakers that are selectable for bass management crossover options depends on the speaker configuration.

#### 4.7.3.2 Single Subwoofer

A bass management configuration with a single subwoofer will mix the low frequency of all crossover channels with the subwoofer. You can select which speakers to cross by assigning them to be “small” speakers in the bass management configuration setup screens.

#### 4.7.3.3 Multiple Subwoofers

When there is more than one subwoofer channel assigned using bass management the LFE channel is evenly mixed between all of the subwoofer channels. The LFE input for the subwoofers is attenuated to compensate for having more than one subwoofer. The summed output level can be adjusted for each subwoofer on the Audio Levels screen

The subwoofers may be configured as either “Mono” or with specific positioning. The Mono subwoofer configuration sets each subwoofer with the same audio mix of the LFE channel with all other channels that are crossed with the subwoofer. There are other subwoofer configurations that identify left/right and front/back positions assigned to each subwoofer.

When left/right subwoofers are used, the speakers on the left will be crossed with the left positioned subwoofer while speakers on the right are crossed with the right positioned subwoofer. The Center, High Center and Top speakers would always be crossed evenly between both sides.

When using Front/Back subwoofers, the front speakers are crossed with front subwoofer while surrounds are crossed with back subwoofer (Sw2). The Top channel is crossed evenly between both Front and Back subwoofers.

An option for three subwoofers is available which has two front subwoofers (left and right), and the third subwoofer in the back. Finally, a 4-subwoofer configuration has left front and right front subwoofers, and left back and right back subwoofers.

#### 4.7.3.4 Subwoofer Audio Processing

Each subwoofer channel from the bass management output can be adjusted downstream the same as other channels. The downstream processing includes Dirac filters, 1/3 octave EQ, Parametric EQ, output channel routing, and high pass /low pass filtering.

#### 4.7.3.5 No Subwoofers

When no subwoofer is installed, the LFE can be mixed with the Left/Right and/or Left Surround/Right Surround speakers by having those speakers selected as “Large” in the Speaker Options screen.

Figure 53 illustrates the LFE input being mixed with the left channel.

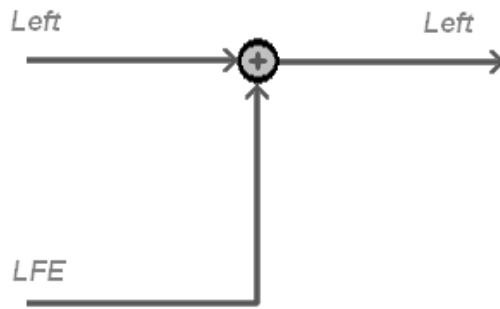

Figure 53. LFE Mixed with Left Channel

#### 4.7.3.6 Low Pass to Other Speaker

Certain speakers have an option to have the low end cross with another speaker, instead of a subwoofer. This may help to keep the positioning of the speaker's low end sound, and also to avoid a large number of speakers being crossed with the subwoofers. This can only be done if the corresponding speaker is defined as a large speaker.

The following speakers can be crossed to other speakers:

- Ls/Rs may be crossed to L/R
- Lb/Rb may be crossed to L/R
- HL/HR may be crossed to L/R
- HC may be crossed to C
- T may be crossed to L/R/Ls/Rs.

#### 4.7.3.7 Phantom Center Option

The Phantom Center option allows you to direct the Center channel to the Left Front and Right Front speakers if there is no Center speaker. There is an offset configuration used to increase or decrease the Center channel level. Note that 0dB offset is the default and includes the 3dB signal level attenuation needed to account for the sound being sent to 2 speakers.

#### 4.7.3.8 Phantom Surround Option

The Phantom Surround option allows you to direct the surround channels to the front speakers. This is used for an installation without the surround channels. The Left Surround channel will be mixed into the Left Front channel and the Right Surround channel will be mixed with the Right Front channel.

#### 4.7.3.9 HP/LP Filter

The slope can be set at either 12dB/octave or 24dB/octave. The cutoff frequency can be set between 31Hz and 160Hz.

#### 4.7.3.10 Offset

The offset control appears only for phantom speaker options. It allows the level for that speaker to be adjusted before being mixed with the Left or Right speaker. The offset level can be adjusted from +3dB to -10dB.

## 4.8 System Setup

The System Setup screen is used to set the brightness and select the screensaver on the LCD screen, in addition to updating the RS20i operating system, setting access password, and saving or restoring the RS20i configuration to/from a USB drive. To access this screen:

### Setup > System



Figure 54. System Setup Screen

The settings and controls available on this screen are described in this table.

Table 31. System Setup (2)

Setting / Control	Description
<b>ScreenSaver Time</b>	Options include a 10 second delay, 1 minute delay, or 5 minute delay before screen saver initiates.
<b>ScreenSaver Mode</b>	<ul style="list-style-type: none"> <li>▪ <b>Disabled</b> will turn off the screen saver.</li> <li>▪ <b>Dim Screen</b> will reduce the touch screen brightness after the time specified in the ScreenSaver Time. Touching the screen or turning the Volume Control knob will restore the brightness.</li> <li>▪ <b>Graphic</b> mode uses the stored screen saver graphic. Touching the screen or turning the Volume Control knob will restore the Home screen.</li> <li>▪ <b>Black Screen</b> will black out the screen after the specified time selected under Screensaver Time.</li> <li>▪ <b>Status Screen</b> shows only the volume level and the current input.</li> </ul>
<b>Digital Out Setup</b>	<p>When interfacing with external digital equipment select appropriate clock rate to match that equipment. See 4.4.6 <i>Audio Levels</i>, page62, for how to configure the digital output to follow the volume control. Select from the following options:</p> <ul style="list-style-type: none"> <li>▪ Off, 48kHz, 96kHz, or 192kHz</li> </ul> <p>Select <b>Off</b> for best performance when using only analog outputs.</p>

Setting / Control	Description
<b>Output Mapping</b>	<ul style="list-style-type: none"> <li>▪ <b>Standard 16 Ch Out</b> – Standard output channel assignments.</li> <li>▪ <b>Copy Ch 1-8 to Ch 9-16</b> – The output of channels 1 through 8 will be <i>copied</i> to output channels 9 through 16 for both the Analog output connector and Digital output connector. Output channels 9-16 are not assignable if this option is used.</li> </ul>
<b>LCD Brightness</b>	Select the Brightness button and use the Volume Control knob to adjust the brightness of your touch screen, 0.5 to 10.0.
<b>LCD Contrast</b>	Select the Contrast button and use the Volume Control knob to adjust the contrast of your touch screen, 0.5 to 2.5.
<b>Update System Software</b>	Update the processor software via the internet. See 4.8.1 <i>Update System Software</i> , page 87.
<b>USB Save/Restore</b>	Save and restore configurations through the USB interface. See 4.8.2 <i>USB Save/Restore</i> , page 89.
<b>Access Control</b>	Assign password protections. See Access Control, page 91.
<b>System Info</b>	View system information and a log file of system messages. See 4.8.4 <i>System Info</i> , page 92.
<b>More</b>	Touch the <b>More</b> button to view the second System Setup screen. See 4.9 <i>System Setup (2)</i> , page 94.

### 4.8.1 Update System Software

There are two ways you can update your software. The first way is to connect to the servers at Datasat Digital Entertainment to select and install the update. This requires that the RS20i is connected to the Internet. The second way is to install the update from a USB Device. Both methods are described in more detail below.

#### Setup > Update

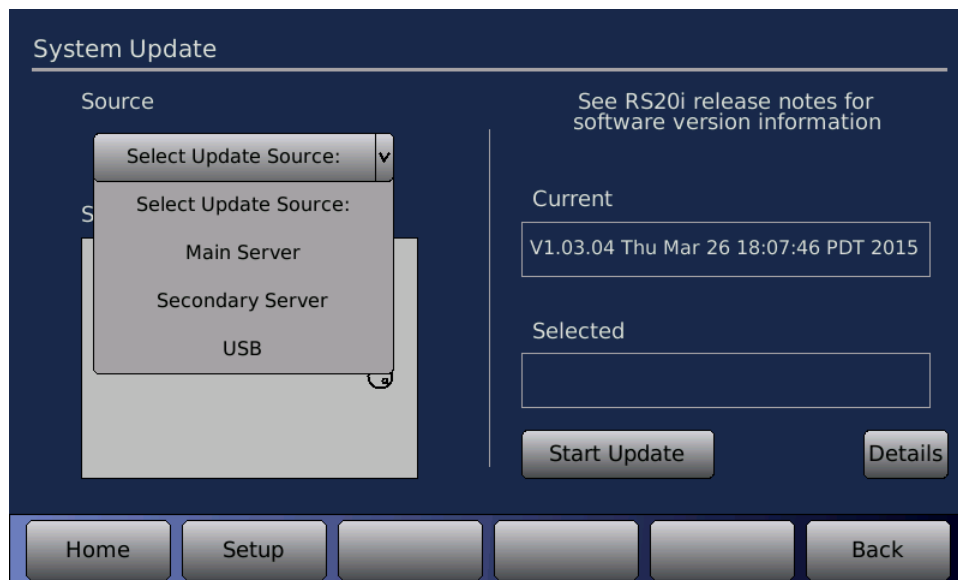

Figure 55. System Update Screen

#### 4.8.1.1 Update System Software from Network

The following steps describe how to update your RS20i software through the internet.

1. Using the **Select Update Source** drop-down list, choose Main Server or Secondary Server. Both selections provide the same list of available software releases. The most recent will always be at the top of the list.

**Note: Your RS20i must already have an active internet connection in order to access the software update list through the internet. If you receive a message “failed to get file list” your internet connection is not working and the RS20i is unable to connect with the server.**

2. Use the Volume Control knob to highlight the desired software version.  
The current version of software loaded on the RS20i is displayed under Current on the right side of the screen. The highlighted software version, will display under Selected on the right side of the screen. Select the Details button to show the timestamp for the selected update.
3. Once the desired version is confirmed, press the **Start Update** button

**Note: If you select an older version of software than is currently loaded on the RS20i, you will receive a warning message and be asked to verify that you wish to continue.**

Connection will take place automatically, and the following screen will appear.



Figure 56. Downloading Software Update via Internet

Depending upon your connection speed, downloading, decompressing, and installing files could take anywhere from 10 minutes to less than a few minutes to complete. After decompressing the file, the system checks if the software is different than the current version. If it is the same version then a pop-up message indicates that the software update is not required. In that case, press OK to return to the menus.

Otherwise, the RS20i automatically reboots to continue the software update process, including updating firmware on various boards. When that completes, the system returns to the Home screen.

#### 4.8.1.2 Update System Software from USB Device

You may update the software through a USB drive.

1. First, obtain the software update file from the Datasat Digital Entertainment web page at [www.datasatdigital.com](http://www.datasatdigital.com)
2. Copy the extracted .upd file to the USB drive root directory.

**Note: The filename of the extracted file must not be changed in order to be correctly identified by the RS20i.**



3. Insert the USB drive into the USB slot on the front panel of the RS20i, choose **Select Update Source > USB**, then select the update file and press the **Start Update** button.

**Note: If you select an older version of software than is currently loaded on the RS20i, you will receive a warning message and be asked to verify that you wish to continue.**

## 4.8.2 USB Save/Restore

A Configuration file includes all configurations (3rd octave EQ, Dirac coefficients, input and output presets, automation, and global configurations) set in the RS20i.

You can save and restore standard configurations and master configurations to a USB Flash drive (memory stick). You can also save Diagnostic information (the system log file) for use in troubleshooting the system.

A *master configuration* is intended to be a template used to configure similar RS20i processors. It may be used as the first step in the configuration of additional installed units. Use the RS20i GUI to save the Master configuration from one RS20i to a USB memory device, then move the USB memory device to a separate RS20i and select Load from USB to copy that configuration file.

**Note: Always be careful, because any existing Master Configuration file on the USB will be overwritten when you save another one.**

The *RS20i Configuration* is specific to one RS20i. The configuration file saved on the USB is given the name "rs20\_nnnn.tgz" where "nnnn" is the serial number of the unit. The standard configuration file can only be loaded back onto the same RS20i.

You can also load a screensaver of your choice via the USB port.

To set any of these options, insert the USB Flash drive into the front panel and then press the **USB Save/Restore** button on the System Setup screen. (If no Flash drive is present, a message will appear prompting you to insert a USB device.)

### Setup > USB



Figure 57. USB Save/Restore Screen

Select an activity on the left, then touch **Copy** on the right.

The options described in the table below are available when using a USB Flash drive.

**Table 32. USB Flash Drive Options**

Option	Result
Save on USB	<p>Save <b>RS20i Configuration</b>. This will erase any previous RS20i Configuration file from this unit on the USB device. The RS20i Configuration file is given the name <i>rs20_nnnn.tgz</i>, where <i>nnnn</i> is the RS20i serial number.</p> <p>Save <b>MasterConfiguration</b>. The MASTER configuration may be loaded onto other RS20i units. This will erase any existing RS20i Master Configuration file on the USB device. The Master Configuration file is given the name <i>rs20_MASTER.tgz</i>.</p> <p>Save <b>Diagnostic Information</b> to the USB device to facilitate troubleshooting. The RS20i Diagnostic file is given the name <i>DIAG_nnnn.tgz</i>, where <i>nnnn</i> is the RS20i serial number.</p>
Load from USB	<p>Copy <b>RS20i Configuration</b> from USB device to system. The RS20i Configuration file is identified by the name <i>rs20_nnnn.tgz</i>, where <i>nnnn</i> is the RS20i serial number. This will ERASE the existing configuration on the RS20i and cause a system restart after loading the new configuration.</p> <p>Copy RS20i <b>Master Configuration</b> from USB device to system. The RS20i Master Configuration file is named <i>rs20_MASTER.tgz</i>. This will ERASE the existing configuration and cause a system restart after loading the new configuration.</p> <p>Load a <b>ScreenSaver</b> graphic image (<i>rs20.jpg</i>) from the USB device. The screensaver must be a jpeg image. The maximum image size is a 800 wide x 480 high (smaller images will be centered). The file must be named "rs20.jpg" and placed in the root directory of the USB device.</p>

### 4.8.3 Access Control

By creating passwords, you can control user access to the Setup GUI and/or network control of the RS20i. To access this screen:

**Setup > Access**

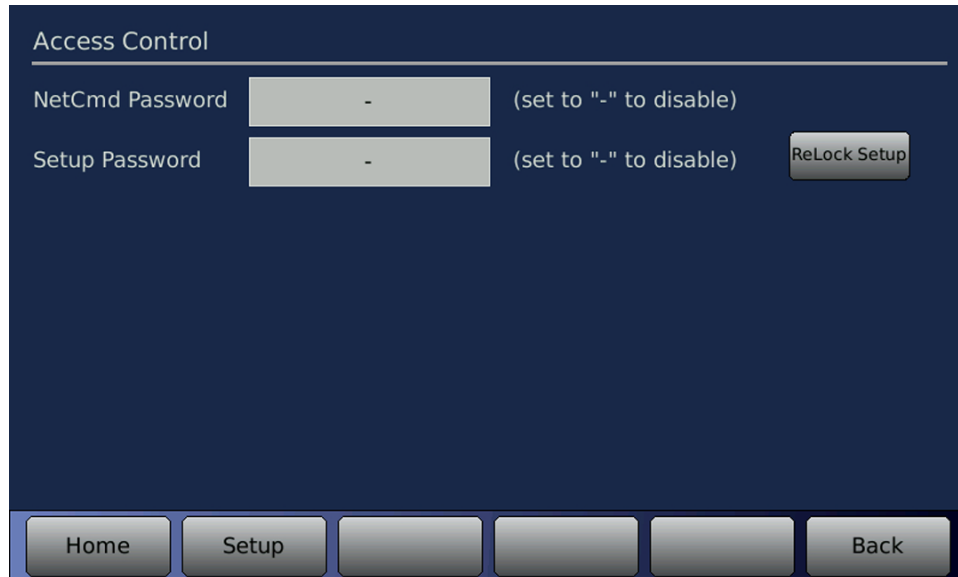

Figure 58. Access Control Screen

1. To add or change password, select the NetCmd or Setup Password text box and use the virtual keyboard (Figure 59).
2. Use the **Clear** button on the keyboard to clear all previous text. Then, enter the new password and select **OK**.

Passwords are case sensitive. You can enter upper case characters by using the Shift button on the virtual keyboard.

Password restrictions take place as soon as the password is configured in the Access Control screen.

The **Netcmd** password is the password used to control access to operator-level commands from a remote network device (such as an automation device or server) or theater management system. See Appendix E for information on remote network control and the API commands.

An operator will be required to enter the Netcmd password for logging into the unit through VNC.

**Note: Changes in the Netcmd password affect the VNC session only after the RS20i has been reset.**

A **Setup** password will restrict users from access to the System Setup menu. A user without the correct password will be prohibited from making any changes to the system, inputs, network, or automation. A VNC user also requires the Setup password to enter the Setup Menus.

The **Setup** password needs to be entered only once when entering the setup menus and remains in effect until:

- the RS20i is powered cycled
- one hour passes with no activity
- the ReLock Setup button on the Access Control screen is pushed

If the password is lost and you cannot access the RS20i, contact Datasat Digital Entertainment technical support.

**To remove password protection**, clear the password by pressing the Clear button, then enter a hyphen “-“ and press **OK**.

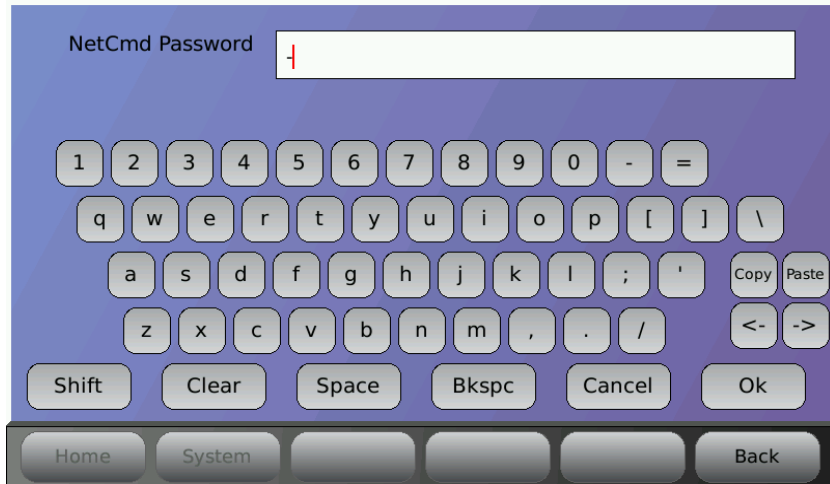

Figure 59. Virtual Keyboard

### 4.8.4 System Info

The System Info screen provides information about the audio processor, including the RS20i software version, build date, serial number, MAC address, and circuit board temperatures. To access this screen:

**Setup > Info**

Board	BrdId	Addr	HwRev	LdrVer	LdrCs	fwVer	fwCs
H531	8	1	1	12	80d3	0.34	581c
H532	9	2	3	12	80d3	0.34	581c
H335	4	31	7	12	80d3	0.34	581c
H336	0	0	3	12	80d3	0.34	581c
H337in	6	1	2	12	80d3	0.34	581c
H337out	6	0	255	12	80d3	0.34	581c
H555	12	5	1	12	80d3	0.34	581c
HDMI	HSR41	F/W Release 41 Version 24 Rev 20					

Tap screen to see more information such as board voltage

Figure 60. System Info Screen

The information presented on this screen is described in this table.

**Table 33. System Info**

Area or Button	Description
<b>Upper left</b>	<p>Version – Identifies the current software version installed on the RS20i.</p> <p>BuildDate – The build date associated with the current software version.</p> <p>SerialNumber – The unique unit serial number.</p> <p>MACAddress – The network MAC address for the unit.</p> <p>Auro Engine – The Auro Engine Version number and build date.</p>
<b>Upper right</b>	<p>Temperatures – The current temperatures in Celsius are displayed for the H531, H532 and H335 boards.</p> <p>Fan – The current fan speed as a percentage. The fan speed may increase to keep the internal temperatures down. The minimum speed is 8%.</p> <p>ModelCode – The RS20i ModelCode (for use by Datasat Digital Entertainment).</p>
<b>Lower area</b>	<p>The lower portion of the screen displays the hardware and firmware version information for the circuit boards (listed in Table 34, below).</p> <p>Tap on the lower portion of the screen to switch to a display of voltages measured from the board. Tap again to return to the firmware version.</p> <p>The information under <b>Board</b>, <b>BoardId</b>, <b>Addr</b>, and <b>HwVer</b> are related to the physical hardware installed in the system, and will not change.</p> <p><b>LdrVer</b> and <b>LdrCs</b> refers to the boot loader on each board, which was programmed during the manufacturing.</p> <p><b>fwVer</b> and <b>fwCs</b> are firmware versions that are loaded by the system software.</p> <p>The <b>Voltage</b> information screen shows expected and measured voltages from select boards. An error in the measured voltage is indicated by <b>RED</b> text, and will trigger an alert on the home screen.</p>
<b>Notices</b>	Select Notices to view Software License information for Open Source Software.

**Table 34. RS20i Circuit Boards**

Board	Function
H531	Inputs and Output Channels 1-8
H532	Output Channels 9-16
H617	Output Channels 17-24 (if installed, this is an option).
H335	DSP board
H336	Front Panel
H337	Serial I/O and Automation
H555	Audio Decoder and triggers
HDMI	HDMI interface card. Supports 4K video formats.

## 4.9 System Setup (2)

The second System Setup screen contains additional settings. To access this screen, touch the **More** button in the Setup screen.

**Setup > System > More**

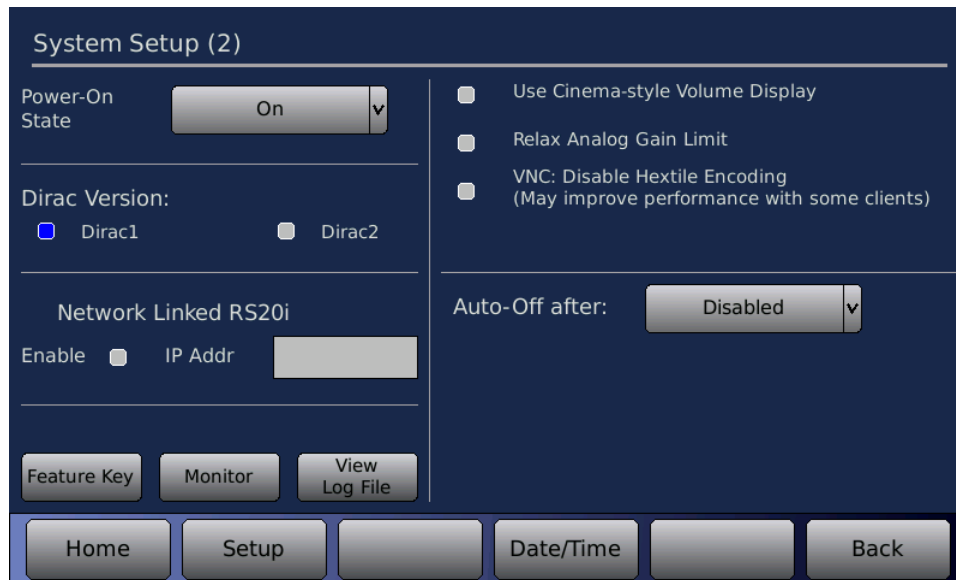

Figure 61. System Setup (2)

**Date/Time** – Touch this button to open the screen for setting the date and time. See 4.9.3 *Date/Time*, page 97.

The settings available on this screen are described in this table.

**Table 35. System Setup (2)**

Setting	Description
<b>Power-On State</b>	<p>Determines whether Standby mode will be enabled after a power-on event either from the back panel switch, or after a power interruption.</p> <ul style="list-style-type: none"> <li>▪ On – The unit remains in the on state.</li> <li>▪ Off – The unit will boot up as normal, then power off (standby Mode).</li> <li>▪ Last Power State – After power up, the unit returns to the mode it was in before the power was turned off (On or standby mode).</li> </ul>
<b>Dirac Version</b>	<p>Select between the first (Dirac1) and second (Dirac2) version of Dirac filters for all of the Dirac setups.</p> <ul style="list-style-type: none"> <li>▪ Select <b>Dirac1</b> (default) if you are using that version of the Dirac Live setup software for alignment. This version may be needed for installations that have been setup before the Dirac 2 version was available. Refer to the Dirac Live Installation Guide for information on how to use Dirac for RS20i setup.</li> <li>▪ <b>Dirac 2</b> is recommended for all new installations provided that the installer has Dirac 2 setup software.</li> <li>▪ After selecting the Dirac Version, the RS20i must be reset from the front</li> </ul>

Setting	Description
	<p>power switch.</p> <p><b>Note:</b> You cannot switch between Dirac1 and Dirac2 filter coefficients without resetting the RS20i. However, when you switch Dirac Versions, the coefficients that are already loaded on the RS20i are not deleted from the system. Therefore, they could still be used after switching back the Dirac Version.</p>
<b>Networked Linked RS20i</b>	<p>Allows the RS20i to control a second RS20i unit using Ethernet commands. <b>The second RS20i unit should also be configured to be linked to this unit's IP address.</b> Changes in the configuration for Volume, Mute status, and Input Selections are sent to the linked RS20i unit. Input Selections should be given the exact same name in order for the input commands to work.</p> <ul style="list-style-type: none"> <li>▪ To use this feature select <b>Enable</b> and select <b>IP Addr</b> to enter the IP address of the other RS20i unit. Once connected, you should see that the volume control sets the volume for both units.</li> </ul>
<b>Feature Key</b>	Touch to open a virtual keyboard for entering the key. This is used to enter an unlock code when upgrading to optional features.
<b>Monitor</b>	Control the volume of an external monitor. See 4.9.1 <i>Monitor Volume</i> , page 95.
<b>View Log File</b>	Touch the button to switch to the Log File screen. See 4.9.2 <i>Log File</i> , page 97.
<b>Use Cinema Style Volume Display</b>	When enabled, the master volume displays as a number from 0.0 to 10.0 in increments of 0.1, which mimics the volume display common in commercial cinema equipment.
<b>Relax Analog Gain Limit</b>	Use if needed to increase the gain on the analog output. It is necessary on some configurations where bass management is used to downmix channels and levels are attenuated to avoid digital clipping. Enable only if you notice an exclamation mark appearing on the master volume control and more gain is required.
<b>VNC: Disable Hextile Encoding</b>	Selecting this option will improve VNC performance for some VNC clients.
<b>Identity</b>	<p>Touch to open a virtual keyboard for entering text.</p> <p>The three text fields in the Identify group are used (optionally) for adding identification or other short text information that is stored with the configuration. These are labeled "<b>Screen</b>", "<b>Info1</b>", and "<b>Info2</b>". These fields may be used to enter useful information, such as the unit location or room and installer name.</p> <p>The text entered in the <b>Screen</b> field is also displayed in the bottom left corner of the Home screen above the navigation menu. This information can be useful for verification of the correct RS20i when connecting through VNC.</p> <p>The Screen, Info1, and Info2 information may be used by a remote theater management system or other custom application software.</p>

## 4.9.1 Monitor Volume

When an external powered speaker is connected to the RS20i monitor output, the level can be controlled using the monitor volume. To adjust the external monitor volume, touch the **Monitor** button in the System Setup (2) screen.

**Setup > System > More > Monitor**

Touching the **Close** button will close this screen. The Monitor Volume window will close automatically if not used within 30 seconds.

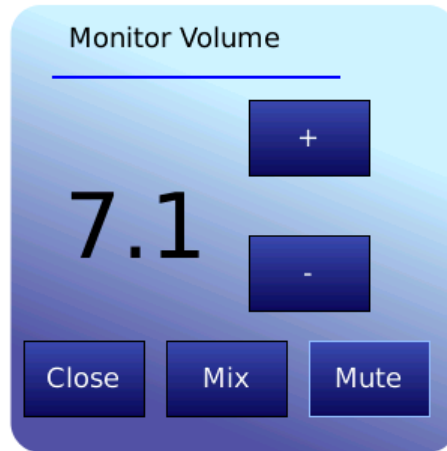
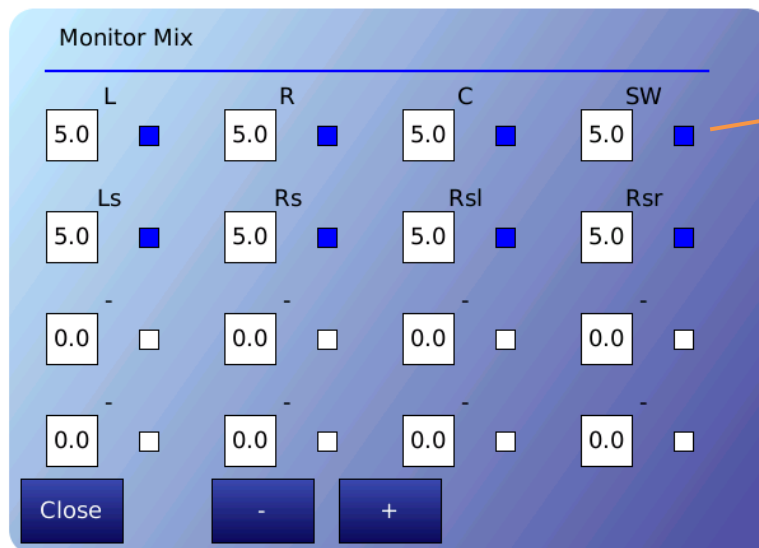

Figure 62. Monitor Volume

- Touch the + or – buttons to raise or lower the volume.
- Touch the **Mute** button to mute/unmute the external monitor.
- Touch the **Mix** button to select a channel and adjust the volume from 0 to 10. See Figure 63, below.



Touch the small button to select a channel for monitoring

Figure 63. Monitor Mix

- **Channel enable:** Touch the small button next to a channel to select it for monitoring.
- **Channel volume:** Select channel(s), then touch the + or – button to adjust volume from 0 to 10.

Touch **Close** to close the Mix window. It also will close automatically after 30 seconds of inactivity.



## 4.9.2 Log File

The log file is a listing of the most recent software events that have taken place since the RS20i was last powered on. The listing includes changes made internally by the RS20i software, as well as user initiated system changes through the touch screen interface. You may scroll through the log file using the front panel Volume Control knob.

**Setup > System > More > View Log File**

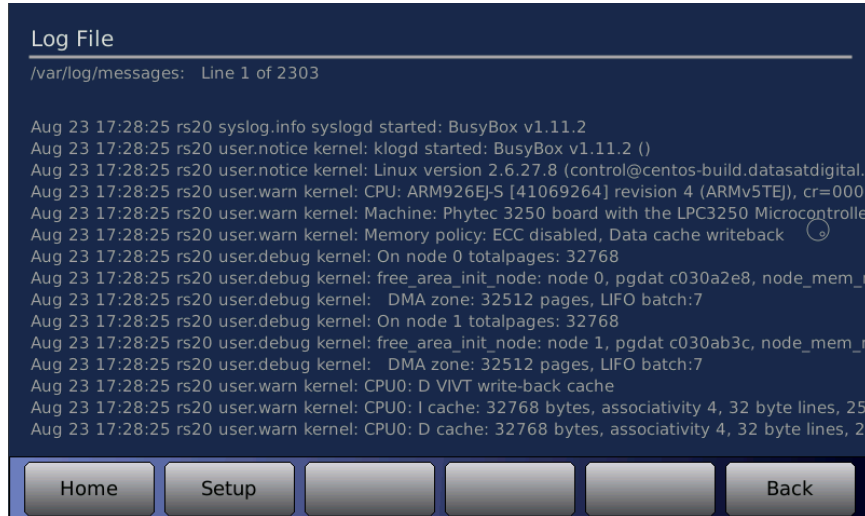

Figure 64. Log File Screen

The log file is helpful for debugging by Datasat Digital Entertainment staff. In some cases, Customer Service may ask an installer to save the log files on the USB Flash drive and send for troubleshooting purposes. If so, you can select **Save Diagnostic Info**. See 4.8.2 *USB Save/Restore* on page 89.

## 4.9.3 Date/Time

Access the Date/Time setup screen from System Setup (2). The time configured on this screen is UTC – Universal Time Code, also known as GMT. You may configure with local time, provided NTP Server is not in use because that would conflict.

**Setup > System > More > Date/Time**

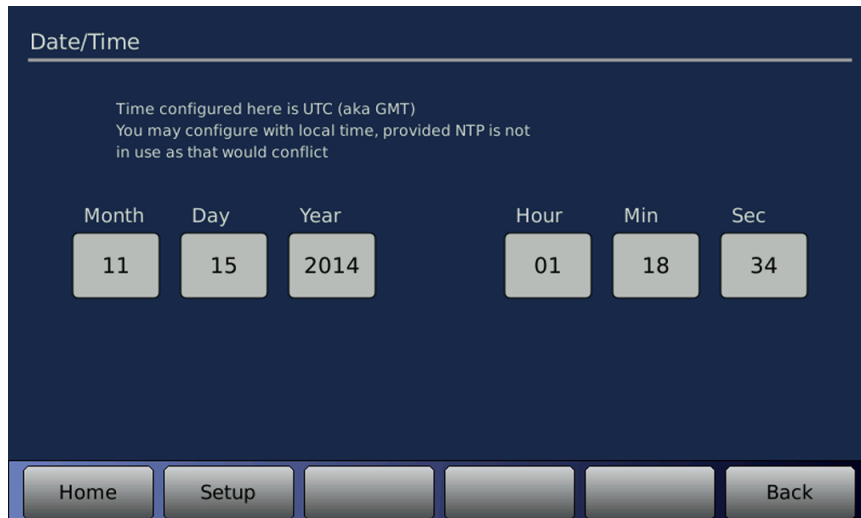

Figure 65. Date/Time Screen

To change the date or time, select a field and use the Volume Control knob on the front panel to change the entry.

## 4.10 Network Configuration

The Network Configuration screen is used to configure and check the network connection to the RS20i. A properly configured network connection is required to use any RS20i network features, including VNC (Virtual Network Connection), remote network control from an automation unit, and remote software update. To access this screen:

**Setup > Network**

The screenshot shows the 'Network Configuration' screen with the following details:

- IP Address:** Current: 10.1.6.59, Mask: 255.255.255.0, Broadcast Addr: 10.1.6.255, Gateway: 10.1.6.1. Configured fields are empty.
- DNS Server 1:** 10.1.5.22, **DNS Server 2:** 10.1.5.23. NTP Server and Log Server fields are empty.
- Mode:** DHCP is selected (checked), Static is unselected.
- Speed:** Auto (dropdown menu).
- Link Up:** 100Mbps Full-duplex.
- Note:** Changes to network config require a rear-panel power-cycle to take effect.
- Navigation:** Home, Setup, Net Diag, SNMP, Back buttons.

Figure 66. Network Screen, DHCP Selected

- To change or enter a value, touch the box under the appropriate label.
- The DNS Server, NTP server and Log file server can be entered whether using DHCP or Static modes.

Table 36. Network Configuration

Field	Description
<b>IP Address</b>	Current and configured IP address. The Configured IP address is one you have entered (while in Static mode). The Current IP address is the one obtained from the server when in DHCP mode, or the Configured IP address when in Static mode. <b>Note:</b> If you switch from DHCP to Static and enter a new IP address into Configured, the IP address shown in Current will not change until you reboot.
<b>Mask</b>	Current and configured netmask, specifies the size of the network. For simple networks this is: 255.255.255.0
<b>Broadcast Addr</b>	This is a single address for devices to communicate with all other devices on the LAN at once. For simple networks, the first 3 number groups are the same as the IP addresses and the 4th group is 255.

Field	Description
<b>Gateway</b>	Current and configured gateway or router, which connects to other networks (for example, to the Internet).
<b>DNS Server 1</b>	Domain Name Server 1, current and configured
<b>DNS Server 2</b>	Domain Name Server 2, current.
<b>NTP Server</b>	Network Time Protocol server, configured, where the correct time will be obtained.
<b>Log Server</b>	Server where the log files will be stored.
<b>DHCP or Static</b>	<p><b>DHCP</b> mode means that when the RS20i is connected to the network, an IP Address is automatically assigned to it.</p> <p>The boxes for IP Address, Mask, Broadcast Addr, Gateway and DNS Server 1 are filled in.</p> <p>In <b>Static IP</b> mode, the installer must assign the IP Address, Mask, Gateway and DNS Server 1.</p>
<b>Speed</b>	Auto, 100 MB/s or 10 Mb/s
<b>Link Up</b>	When the RS20i is successfully connected to the network, the text <b>Link Up</b> will be displayed along with the connection type. The options are: 10Mbps Full-duplex or 100Mbps Full-duplex
<b>Net Diag</b>	See 4.10.1 <i>Network Diagnostics</i> , page 99.
<b>SNMP</b>	See 4.10.2 <i>SNMP Agent</i> , page 100.

## 4.10.1 Network Diagnostics

Setup > Network > Net Diag

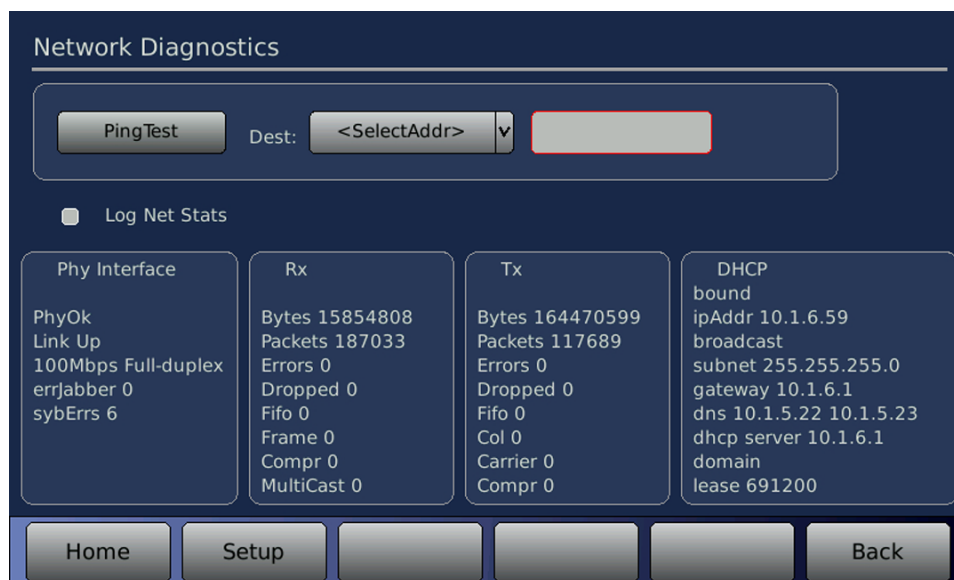

Figure 67. Network Diagnostics Screen

**Table 37. Network Diagnostics Screen**

Field	Description
<b>Ping Test</b>	<b>Network Ping Test</b> – Tests whether the remote network device can be accessed through the network.
<b>Dest: &lt;SelectAddr&gt;</b>	Selects the remote computer or IP address for the ping test. Open drop-down and select: Gateway DNS Server NTP Server Log Server Datasat  Click on the text box to enter or change an IP address. Then a virtual keyboard screen opens, where you enter the IP address.
<b>Log Net Stats</b>	<b>Log Network Statistics</b> – Enable this to include additional network events in the log to troubleshoot a network problem. This option is always disabled after a power cycle.
<b>Phy Interface</b>	Physical interface
<b>Rx</b>	Monitors Receive activity.
<b>Tx</b>	Monitors Transmit activity.
<b>DHCP</b>	DHCP address

#### 4.10.1.1 Is there an Internet Connection?

Some local area networks (LANs) have a connection to the internet, some do not. In order to update the RS20i from the Datasat Digital Entertainment server, there must be an internet connection. To test this, use the **Ping Test** utility on the Network Diagnostics screen.

On the Network Diagnostics screen, enter a known IP address for a remote device in the box to the right of the **<SelectAddr>** box, or select a device from the **<SelectAddr>** dropdown box. Tap **Ping Test** and observe the message.

- 'OK' means the RS20i is connected to the same network.
- 'FAIL' means that the network was not able to connect to the remote device.

If the network administrator says there should be an internet connection but the ping to 'Dest' is **not OK**:

- Check that the network cables are plugged into the equipment (RS20i, Projector, Server etc).
- Check the power and network cables to the switch and the internet router (gateway). Check each network connection; most switches have LEDs that show a good connection. If there is more than one network, make sure you are looking at the relevant switch.
- Use the **Dest:** box on the **Ping Test** to check the **'gateway'** is **'OK'**.
- If there is PC connected to the same LAN, open an internet browser and go to any public web site such as <http://www.auro-technologies.com>

### 4.10.2 SNMP Agent

SNMP is an internet-standard protocol for managing devices on IP networks. To access this screen:

Setup > Network > SNMP

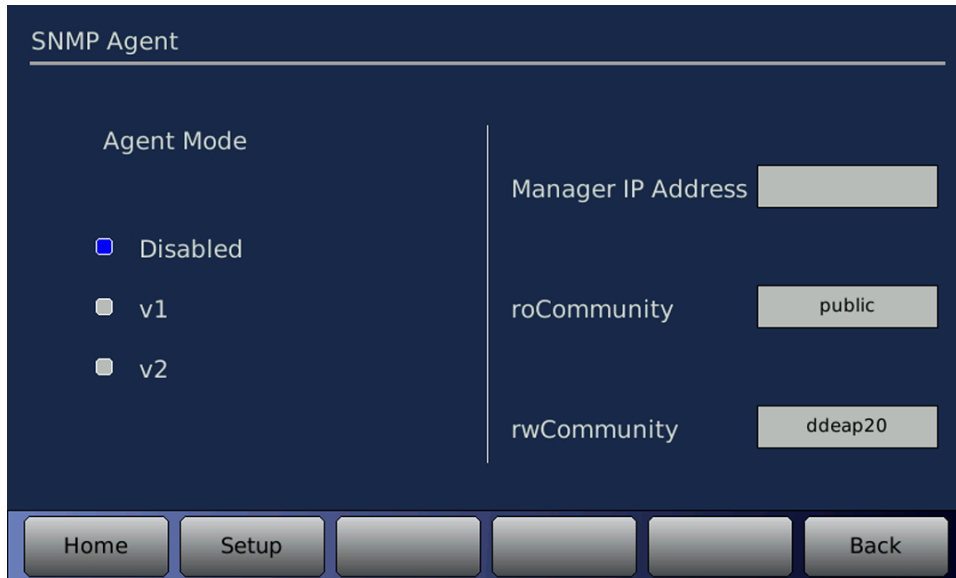

Figure 68. SNMP Setup Screen

- **Agent Mode** – If set to disabled, the SNMP is turned off. When enabled the SNMP agent mode may be set to v1 (SNMPv1) or v2 (SNMPv2) to match the SNMP server requirement.
- **Manager IP Address** – Set this to the IP address to send SNMP trap messages.
- **roCommunity** – This is the access code for SNMP read messages.
- **rwCommunity** – This is the access code for SNMP write messages.

## 4.11 Automation Macros

The Automation Macros menus allow you to create a script of multiple actions. A Macro may then be assigned to an Event, an automation button, or included as part of a separate Macro. The menu bar contains an **Events** button to allow easy navigation between the Events screen and the Macros screen when building Macros and assigning them to Events.

Setup > Macros

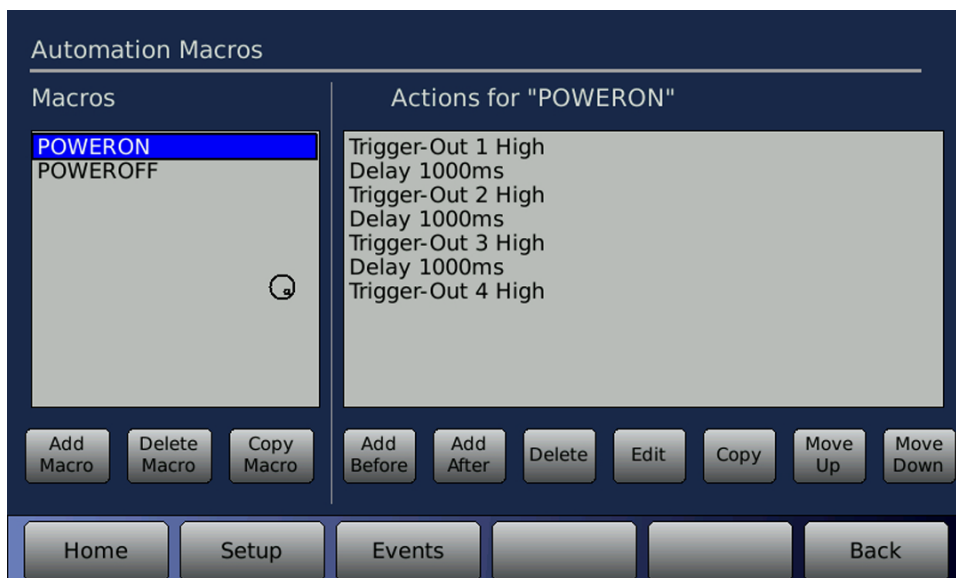

Figure 69. Automation Macros screen

When Automation Macros is selected, a list of existing Macros are displayed. Scroll through the list of Macros using the front panel Volume Control knob. When an existing Macro is highlighted the actions making up that Macro are displayed. The example in Figure 69 shows the POWERON Macro.

**Note: The macros named POWERON and POWEROFF are automatically executed during the power-on and power-off cycle, respectively.**

The controls on this screen are described in this table.

**Table 38. Automation Macros Screen**

Control	Description
<b>Add Macro</b>	See 4.11.1 <i>Add Macro</i> , page 102.
<b>Delete Macro</b>	Deletes the selected macro.  <b>Note:</b> When <b>Delete</b> is pressed, the system opens a pop-up window. Press the <b>Delete</b> button to confirm the deletion, or press the <b>Cancel</b> button to cancel the deletion. Once <b>Delete</b> is confirmed, the Macro and all Actions assigned to it are deleted.  ⚠ <b>CAUTION:</b> A macro may be deleted even if it is associated with an Event and assigned to an Automation button.
<b>Copy Macro</b>	Copies the selected macro. See 4.11.2 <i>Copy Macro</i> , page 103.
<b>Add Before</b>	Adds a new Action before the selected Action.
<b>Add After</b>	Adds a new Action after the selected Action.
<b>Delete</b>	Delete the selected macro Action.
<b>Edit</b>	Opens Automation Edit Actions screen to edit the selected event. See 4.12 <i>Automation Edit Action</i> , page 103.
<b>Copy</b>	Copy the selected macro Action.
<b>Move Up</b>	Move selected Action up the Actions list.
<b>Move Down</b>	Move selected Action down the Actions list.
<b>Events</b>	Opens the Automation Events screen.

### 4.11.1 Add Macro

- To add a Macro, select the **Add Macro** button. The virtual keyboard screen will appear where you enter a Macro name.
- Enter a name that is meaningful. A name of up to 15 characters will be displayed. The new Macro name will appear on the list and its **Actions** list will be blank.
- Touch the box under “Actions for <macro name>”. Actions may now be added.
- Touch **Add After** to enter the first action. This will bring up the **Automation Edit Action** screen, shown on page 103.
- Continue to define the Macro script by adding Actions before or after existing Actions (highlight existing actions using the front panel Volume Control knob). Existing Actions may also be highlighted and edited (touch the **Edit** button), moved up or down in the sequence (**Move Up**, **Move Down**), or removed (touch the **Delete** button). Touch **Copy** to copy an action to repeat it or to edit it.

### 4.11.2 Copy Macro

This feature is useful to create a macro similar to an existing macro without re-entering all the events. After the macro is copied, just change or edit events that should be different.

1. To copy a Macro, first highlight the source macro, then touch the **Copy Macro** button. A keyboard will appear to enter the name of the new macro.
2. After entering the new macro name, press **OK** to return to the Macro list with the new macro added.

## 4.12 Automation Edit Action

This screen is accessed via either the **Edit**, **Add Before**, or **Add After** button in the Automation Macros screen. It is also used for defining an Action for an event.

**Setup > Macros > Edit**

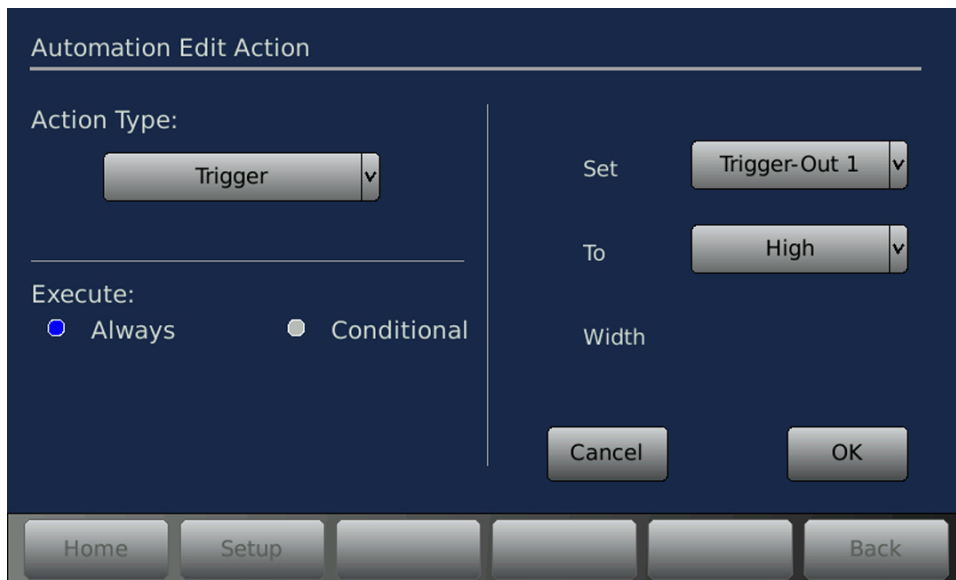

Figure 70. Automation Edit Action screen

The options on the right side of the screen depend on the Action Type selected on the left side. The controls on this screen are described in this table.

**Table 39. Automation Edit Action**

Control	Description
<b>Action Type</b>	Select an action type from the drop-down list. See the instruction following this table.
<b>Execute</b>	Select <b>Always</b> or <b>Conditional</b> Conditional means that the Action will execute based on a Variable being assigned as True or False. When Conditional is selected, a text box appears where the variable may be entered. Then select True or False in the drop-down list. The conditional variable that is used should be assigned to True or False as part of a separate action.
<b>Cancel / OK</b>	When finished, touch <b>OK</b> to confirm or <b>Cancel</b> to undo.

1. Select an **Action Type** from the drop-down list, using the up/down arrow keys or the mouse scroll wheel.
  - **Delay** is set in milliseconds (ms) with a range of 0-10000ms (10 seconds).
  - **GPO** – Set a general purpose output pin to High or Low, or issue a low-going pulse that may be extended from 100 to 1000 ms.
  - **Input** – select an Input Preset from the **Change Input To** drop-down list.
  - **Network** – Send a TCP command to a network device. The IP address and TCP port must also be entered.
  - **Mute** – Select **On** or **Off**.
  - **Volume** – The master volume control can be **Set** to a specified value, or it can be incremented or decremented (**Adjust**) by a specified value.
  - **Serial** – Output serial data on the serial automation port. The data must be entered in the **Data** text box.
  - **Set Variable** – Enter the **Variable Name** and set the variable to either **True** or **False**.
  - **Run Macro** – Run the Macro defined by the **Macro Name** text box. Touch the text box to open a virtual keyboard to enter a name.

<p><b>Note: This application accepts only Latin alphanumeric characters.</b></p>
--

- **Trigger** – In the **Set** field, select which Trigger output (1 through 4) to use. In the **To** field, select Pulse, Low, or High. If Pulse is selected, then enter a value in the Width field. The pulse width can be set between 100ms and 1000ms in 5ms increments.
  - **Run Command** – Touch the **Cmd** field to open a virtual keyboard. Enter a RS20i command to be run. Any RS20i command defined by the RS20i command API can be executed by this action. The RS20i API command definitions are in Appendix E, RS20i Command API. Do not include the leading '@' character, or the trailing carriage return when entering the command as a Run Command action (they are necessary only for remote serial or network commands).
2. Touch **OK** when finished, or touch **Cancel** to cancel this setup.



## 4.13 Automation Events

### Setup > Events

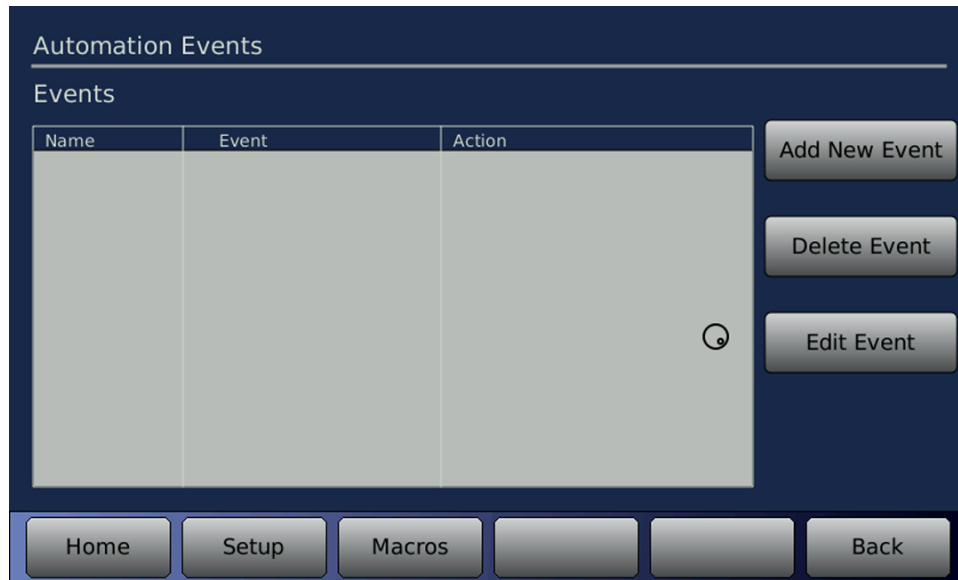

Figure 71. Automation Events Screen

Existing events will be displayed in the Automation Events screen. The front panel Volume Control knob must be used to move the selection bar to an existing event for editing. The list will scroll when needed going past the end when there are more events in the list.

The menu bar contains a **Macros** button to allow easy navigation between the Events screen and the Macros screen when building Macros.

The options on the right side of the screen depend on the Action Type selected on the left side. The controls on this screen are described in this table.

Table 40. Automation Events

Control	Description
<b>Add New Event</b>	Add a new event.
<b>Delete Event</b>	Delete selected event.
<b>Edit Event</b>	Edit the selected event.
<b>Macros</b>	Opens the Automation Macros screen.

### 4.13.1 Add New Event

Selecting the **Add New Event** button opens the **Automation Edit Event** screen and automatically assigns a temporary event name (EV0), which is added to the event list.

Setup > Events > Add New Event

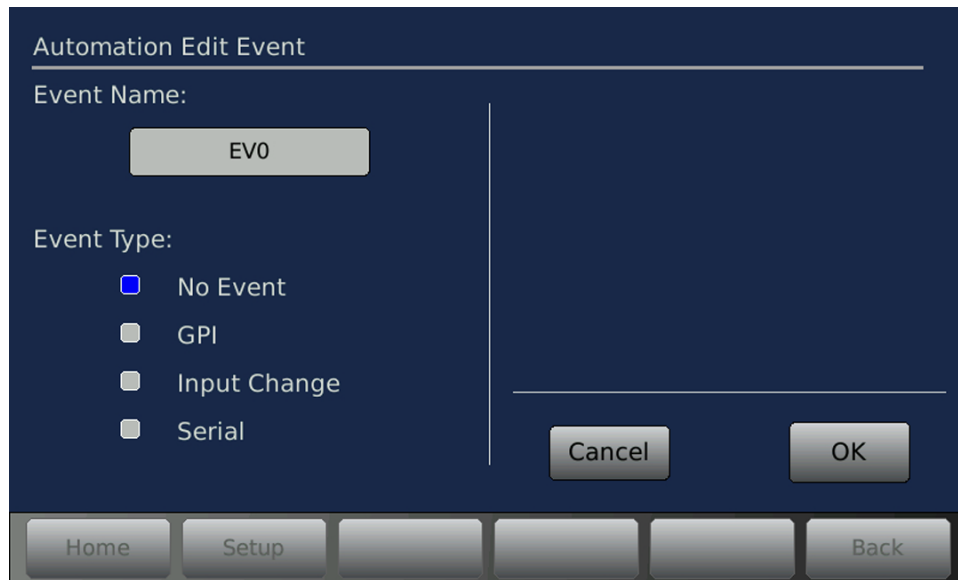

Figure 72. Automation Edit Event Screen

When an event is first added the event type defaults to **No Event**, this means the event type is not configured and should be replaced with one of the other event types.

The controls on this screen include these:

Table 41. Automation Edit Event

Control	Description
Event Name	Tap the <b>Event Name</b> box to open the keyboard screen and allow editing of the event name. Choose a name that is meaningful.
Event Type	GPI Input Change Serial  Depending on the event type, actions appear on the right side of the screen to configure the selected event. Action Types are described on page 104.

## 4.14 Automation Buttons

The Automation Buttons screen shows existing buttons assigned to an Event. Information on the associated event appears below each configured button.

Setup > Buttons



Figure 73. Automation Buttons

To configure a button, touch the button to select it.

A screen will open that allows both the button title and the event assignment to be configured.

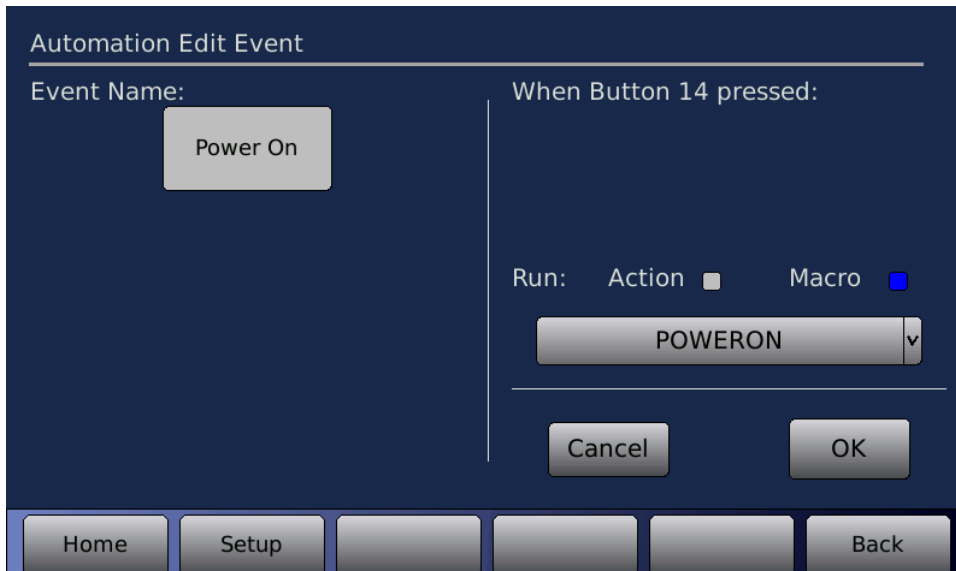

Figure 74. Automation Button Assignment

- To enter or change the button title, touch the **Event Name** box. A keyboard screen will open allowing you to type a new title for this button.
- To assign a macro to the button, touch the **Run: Macro** button, then touch the drop down list and select from the listing. Touch **OK** when finished, or touch **Cancel** to cancel this task.
- To assign an Action to the button, touch the **Run: Action** button and touch the white box that appears below it. This will bring up the **Automation Edit Action** screen.
- Touch **OK** when finished, or touch **Cancel** to cancel this task.

## 4.15 Automation Serial Setup

Use this screen to set up the RS232 serial port on the RS20i rear panel.

**Setup > Serial**

Automation Serial Setup

RS232 Port A

BaudRate 115200

Data Bits 8

Parity None

---

Serial Command Mode RS20i

Home Setup [ ] [ ] [ ] Back

Figure 75. Automation Serial Setup

On this screen, select from the drop-down lists for these parameters:

- Baud rate
- Data Bits
- Serial Command Mode – Command Mode, RS20i Commands, or Linked RS20i

## 4.16 Automation GPIO Test

The Automation Test Screen provides an easy way to test that the automation signals to and from the RS20i are correctly wired and operational.

Setup > Test

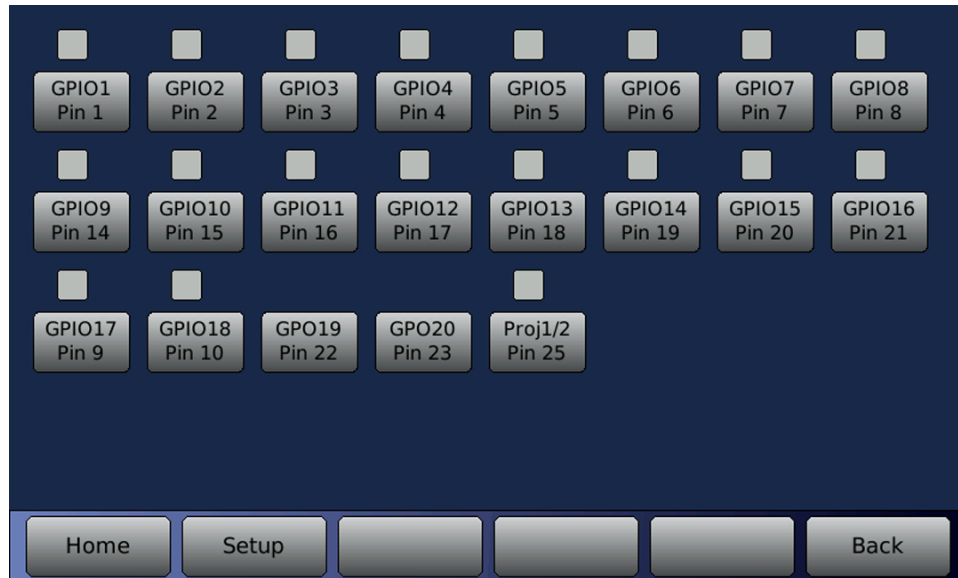

Figure 76. Automation Test

- The screen displays a series of automation buttons, one for each automation output signal (GPO), and an indicator above it that represents the signal input (GPI) state. Note: GPO19 and 20 are outputs only and do not have an input indicator. The input indicator is white when the signal is high or just unconnected. The input indicator turns blue when there is a low signal applied to the pin.
- To verify that the RS20i is properly receiving an input from an external source you would need to make the external device send a low signal on that pin. Then confirm that the signal is received by the RS20i by checking if the corresponding indicator turns blue.

Example: The button at right illustrates when receiving an input signal on GPIO1.



- To test an output signal, press the Automation Button. It creates a low pulse on the corresponding output pin. The button turns blue in conjunction with the output signal being low.

Example: The button at right shows GPIO3 has been selected. Note that the indicator will also turn blue after pressing the button, indicating that it is reading the low signal on the same pin.



## 5.0 Maintenance and Troubleshooting

Check the Datasat Digital Entertainment Online Support site, at [www.datasatdigital.com](http://www.datasatdigital.com), for the latest information on maintenance, troubleshooting, and RS20i software versions.

### 5.1 Routine Maintenance

Clean the touch screen as needed with a soft cloth and non-abrasive cleaning solution suitable for cleaning LCD screens.

### 5.2 Troubleshooting

The following table provides troubleshooting data for the RS20i.

**Table 42. RS20i Troubleshooting**

Problem	Solution
The Home screen displays NoLock	See <i>NoLock</i> , page 111.
Volume control not functioning	See <i>Volume Control Not Functioning</i> , page 112.
RS20i will not power ON	<p>Press and release the power button on the front panel. If the unit will not power up, be sure the rear panel power switch is ON and the unit is plugged into a working AC outlet protected by a surge protector. See <i>Powering ON the RS20i Processor</i>, page 13.</p> <p>If the RS20i is mounted in a rack and a breaker is used for the rack, make sure the breaker is ON.</p> <p>Verify the surge protector is powered and is working.</p> <p>Try changing the RS20i power cord.</p> <p>If power is getting to the RS20i but it still will not power ON, maybe the fuse above the AC In connector (on the rear panel) is blown and/or the input voltage setting is incorrect. See section 2.4.4 for more information or call a qualified installer to check it.</p>
RS20i front panel display is too dim	The front panel display may be set to automatically dim. Gently touch the display screen to brighten it.
No sound	<p>On the front panel display, verify that the RS20i is not muted (Mute button text will be red if muted). Unmute by touching the Mute button.</p> <p>Be sure the volume control level is not too low (-70dB). Turn the knob to increase the volume.</p> <p>Verify the RS20i is set to the correct input.</p>
Alert: Over-Temperature	See 5.2.1 Over-Temperature Alert, page 111.

## 5.2.1 Over-Temperature Alert

If the internal temperature of the RS20i reaches a critical level of 50°C or greater, a red flashing alert indicator will appear.



Figure 77. Over-Temperature Alert message

The flashing alert message appears only on the Home screen. The RS20i will remain operational and the menus can be accessed as usual. The actual circuit board temperatures appear on the System Info page (Setup > System Info). The alert condition overrides, or temporarily disables the screensaver mode if it is set. The alert will stop if the temperature cools below 50°C.

**Note:** This alert message often indicates that there is a problem with proper air flow through the vent holes on both sides of the RS20i chassis. Check that there is nothing obstructing these air vents. Be sure that the fan is spinning (you will feel air blowing out of the RS20i from the fan). If the vents are clear and the fan is spinning, yet the temperature alert does not stop, call your installer for service.

## 5.2.2 NoLock

If the source is a digital input and there is no clock signal, then the display will show “Dig NoLock” as shown below.

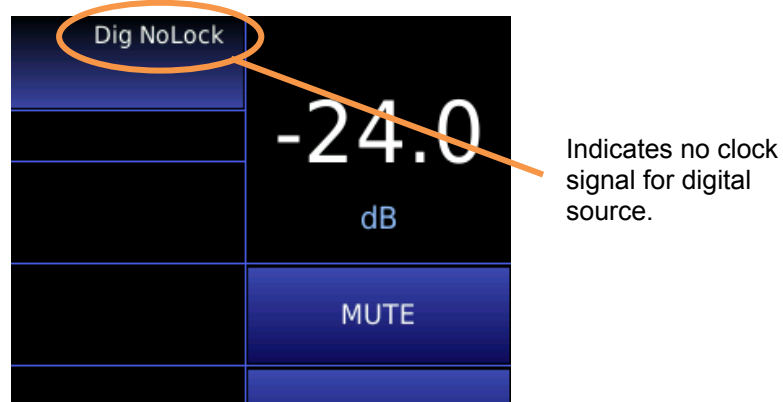

Figure 78. NoLock

## 5.2.3 Volume Control Not Functioning

If the front panel volume control becomes damaged, use the following work around until it can be replaced.

Using your finger, double-tap the volume control level number displayed in the box at the top right corner on RS20i's touch screen. Once you double-tap, a set of arrows will appear that can be used to adjust the main volume up or down. To increase volume, touch the right arrow. To decrease volume, touch the left arrow. To make the arrows disappear, simply double-tap the volume control level number again.



Figure 79. Volume control Adjustment Work Around

## 5.3 Error Messages

### 5.3.1 Software Installation



Figure 80. USB Device Not Found

If you encounter this error message, be sure you have inserted a USB device into the RS20i. If a device is present, it may be malfunctioning. Replace the USB device with another to see if the problem is resolved.





Figure 81. Downloading Error

You may encounter this message (Figure 81) when attempting to upgrade the RS20i operating system software through an internet connection. This message indicates there is a problem with the physical connection between your processor and the outside world. Check your cables, router, modem, or IP addressing scheme, as applicable, to make sure all is in order.

### 5.3.2 Error Booting the RS20i

If, during boot up, an object (such as your finger) is in contact with the touch screen, the software will fail to load. The message below will appear, and continues to scroll past until power is recycled at the power entry module (hard boot).

```
*****
mount: mounting /dev/sda1 on /tmp/usb failed: No such device or address
mount: mounting /dev/sda on /tmp/usb failed: No such device or address
*****
```

To solve this problem, reboot the RS20i, making sure nothing is in contact with the touch screen during the boot-up process.

## Appendices

On the pages that follow:

Appendix A Connector Pinouts .....	A-1
Appendix B Interface Wiring Diagrams .....	B-1
Appendix C Product Specifications .....	C-1
Appendix D Speaker Configurations .....	D-1
Appendix E RS20i Remote Command API.....	E-1

## Appendix A. Connector Pin-outs

This appendix lists the pin-out of all of the connectors on the back panel of the Auro RS20i Audio Processor.

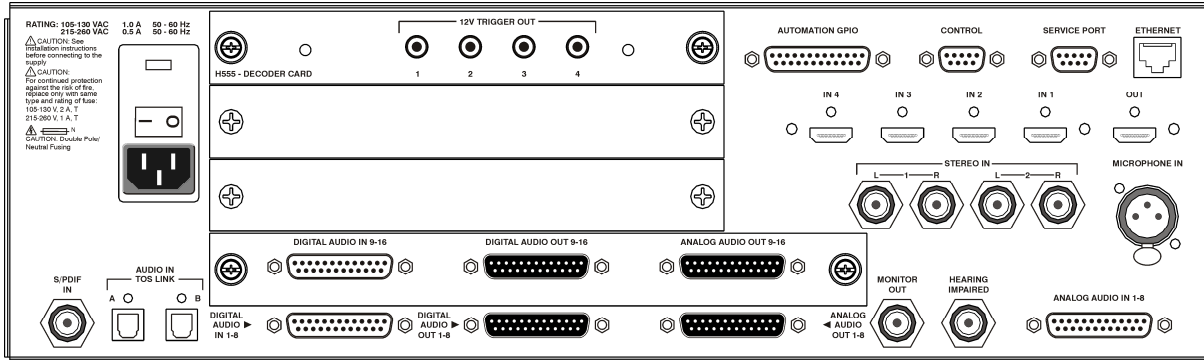

Figure 1. RS20i Rear Panel

TRIGGER OUT 12V – 3.5mm MONO JACK	
Pin	Description
TIP	Trigger out
SLEEVE	Ground

3.5mm MONO JACK



AUTOMATION GPIO – DB25F	
Pin	Description
1	GPIO 1 (Input 0)
2	GPIO 2 (Input 1)
3	GPIO 3 (Input 2)
4	GPIO 4 (Input 3)
5	GPIO 5 (Input 4)
6	GPIO 6 (Input 5)
7	GPIO 7 (Input 6)
8	GPIO 8 (Input 7)
9	GPIO 17
10	GPIO 18
11	N/C
12	RS20i GND
13	RS20i Ext. 5 volts (140mA max)
14	GPIO 9 (Input ID 0)
15	GPIO 10 (Input ID 1)
16	GPIO 11 (Input ID 2)
17	GPIO 12 (Input ID 3)
18	GPIO 13 (Input ID 4)
19	GPIO 14 (Input ID 5)
20	GPIO 15 (Input ID 6)
21	GPIO 16 (Input ID 7)
22	GPO 19
23	GPO 20
24	N/C
25	PROJECTOR C/O (1 / 2)

N/C = No connection

25-PIN FEMALE "D"

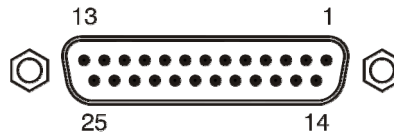

<b>CONTROL (RS232)– DB9F</b>	
<b>Pin</b>	<b>Description</b>
1	N/C
2	Data out - TXD
3	Data in - RXD
4	Connected to pin 6
5	Chassis GND
6	Connected to pin 4
7	Connected to pin 8
8	Connected to pin 7
9	N/C

N/C = No connection

9-PIN FEMALE "D"

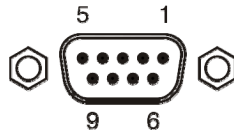

<b>SERVICE PORT (RS232)– DB9F</b>	
<b>Pin</b>	<b>Description</b>
1	N/C
2	Data out - TXD
3	Data in - RXD
4	Connected to pin 6
5	Chassis GND
6	Connected to pin 4
7	Connected to pin 8
8	Connected to pin 7
9	N/C

N/C = No connection

9-PIN FEMALE "D"

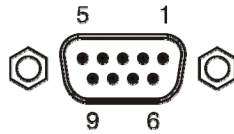

<b>ETHERNET – RJ45F</b>	
<b>Pin</b>	<b>Description</b>
1	TX D1 (+)
2	TX D1 (-)
3	RX D2 (+)
4	Not used
5	Not used
6	RX_D2 (-)
7	Not used
8	Not used

8-PIN FEMALE RJ45

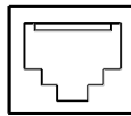

HDMI IN 1-4, OUT – HDMI	
Pin	Description
1	TMDS Data 2 (+)
2	TMDS Data 2 (Shield)
3	TMDS Data 2 (-)
4	TMDS Data 1 (+)
5	TMDS Data 1 (Shield)
6	TMDS Data 1 (-)
7	TMDS Data 0 (+)
8	TMDS Data 0 (Shield)
9	TMDS Data 0 (-)
10	TMDS Clock (+)
11	TMDS Clock (Shield)
12	TMDS Clock (-)
13	CEC
14	N/C
15	DDC Clock
16	DDC Data
17	Ground
18	+5 V
19	Hot Plug Direct

N/C = No connection

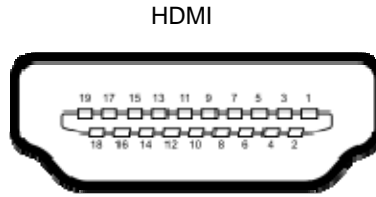

### Hearing Impaired, Monitor Out, Stereo Inputs 1&2, S/PDIF In – RCA

RCA FEMALE	
Pin	Description
Center	Signal
Outer	Ground

RCA FEMALE



MICROPHONE IN – XLR F	
Pin	Description
1	Microphone Ground
2	Microphone In (+)
3	Microphone In (-)

3-PIN XLR FEMALE

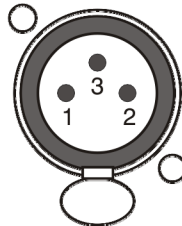

<b>DIGITAL AUDIO IN (CH 1 – 8) – DB25F</b>	
<b>Pin</b>	<b>Description</b>
1	Chassis Ground
2	AES 1/2 -
3	AES 3/4 +
4	Chassis Ground
5	AES 5/6 -
6	AES 7/8 +
7	Chassis Ground
8	N/C
9	Chassis Ground
10	N/C
11	N/C
12	Chassis Ground
13	N/C
14	AES 1/2 +
15	Chassis Ground
16	AES 3/4 -
17	AES 5/6 +
18	Chassis Ground
19	AES 7/8 -
20	Chassis Ground
21	N/C
22	N/C
23	Chassis Ground
24	N/C
25	N/C

N/C = No connection

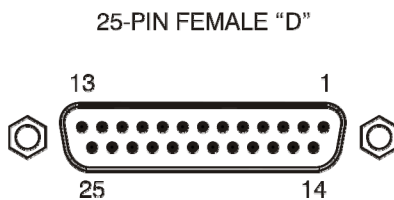

<b>DIGITAL AUDIO IN (CH 9 – 16) – DB25F</b>	
<b>Pin</b>	<b>Description</b>
1	Chassis Ground
2	AES 9/10 -
3	AES 11/12 +
4	Chassis Ground
5	AES 13/14 -
6	AES 15/16 +
7	Chassis Ground
8	N/C
9	Chassis Ground
10	N/C
11	N/C
12	Chassis Ground
13	N/C
14	AES 9/10 +
15	Chassis Ground
16	AES 11/12 -
17	AES 13/14 +
18	Chassis Ground
19	AES 15/16 -
20	Chassis Ground
21	N/C
22	N/C
23	Chassis Ground
24	N/C
25	N/C

N/C = No connection

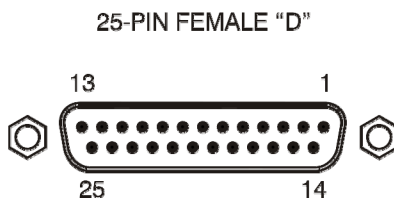

<b>DIGITAL AUDIO OUT (CH 1 – 8) – DB25M</b>	
<b>Pin</b>	<b>Description</b>
1	Chassis Ground
2	AES 1/2 -
3	AES 3/4 +
4	Chassis Ground
5	AES 5/6 -
6	AES 7/8 +
7	Chassis Ground
8	N/C
9	Chassis Ground
10	N/C
11	N/C
12	Chassis Ground
13	Word Clock Out
14	AES 1/2 +
15	Chassis Ground
16	AES 3/4 -
17	AES 5/6 +
18	Chassis Ground
19	AES 7/8 -
20	Chassis Ground
21	N/C
22	N/C
23	Chassis Ground
24	N/C
25	N/C

N/C = No connection

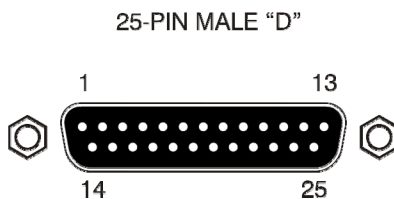

<b>DIGITAL AUDIO OUT (CH 9 – 16) – DB25M</b>	
<b>Pin</b>	<b>Description</b>
1	Chassis Ground
2	AES 9/10 -
3	AES 11/12 +
4	Chassis Ground
5	AES 13/14 -
6	AES 15/16 +
7	Chassis Ground
8	N/C
9	Chassis Ground
10	N/C
11	N/C
12	Chassis Ground
13	Word Clock Out
14	AES 9/10 +
15	Chassis Ground
16	AES 11/12 -
17	AES 13/14 +
18	Chassis Ground
19	AES 15/16 -
20	Chassis Ground
21	N/C
22	N/C
23	Chassis Ground
24	N/C
25	N/C

N/C = No connection

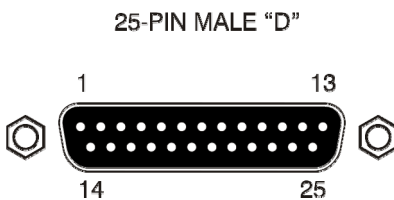

Datasat Digital Entertainment offers a DB25 male to female cable, 3-feet long, for hook-up (P/N 9022H51901). If wiring your own cable, the following criteria must be met:

1. Cable must be double shielded to conform to FCC\CE RF radiation emission limits. Ground shield on the RS20i end.
2. Conductors must be 28-AWG or larger.
3. Choose a paired AES/EBU Digital Audio Cable (such as Belden 7890A). To prevent signal degradation, cable length should be kept as short as possible. If the cable is being run through conduit, it is recommended that it be tested before installing, especially if approaching the maximum length stated in the chosen cable's spec.

ANALOG AUDIO OUT (CH 1 – 8) DB25M	
Pin	Description
1	ANALOG GND
2	CHANNEL 1 (+)
3	CHANNEL 7 (-)
4	ANALOG GND
5	CHANNEL 3 (+)
6	CHANNEL 8 (-)
7	ANALOG GND
8	CHANNEL 2 (+)
9	ANALOG GND
10	CHANNEL 5 (-)
11	CHANNEL 6 (-)
12	CHANNEL 4 (-)
13	ANALOG GND
14	CHANNEL 1 (-)
15	ANALOG GND
16	CHANNEL 7 (+)
17	CHANNEL 3 (-)
18	ANALOG GND
19	CHANNEL 8 (+)
20	CHANNEL 2 (-)
21	N/C
22	ANALOG GND
23	CHANNEL 5 (+)
24	CHANNEL 6 (+)
25	CHANNEL 4 (+)

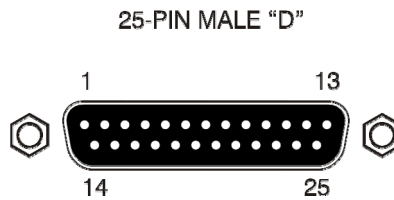

N/C = No connection

- Note: RS20i Analog channels are designed to be balanced, not single ended, for highest sound quality. If wiring single ended, wire only to (+) and ground. The (-) side of the channels should not be connected. Do not short the (-) sides of the channels to ground, which will degrade sound quality and cause the RS20i to overheat.

ANALOG AUDIO OUT (CH 9 – 16) DB25M	
Pin	Description
1	ANALOG GND
2	CHANNEL 9 (+)
3	CHANNEL 15 (-)
4	ANALOG GND
5	CHANNEL 11 (+)
6	CHANNEL 16 (-)
7	ANALOG GND
8	CHANNEL 10 (+)
9	ANALOG GND
10	CHANNEL 13 (-)
11	CHANNEL 14 (-)
12	CHANNEL 12 (-)
13	ANALOG GND
14	CHANNEL 9 (-)
15	ANALOG GND
16	CHANNEL 15 (+)
17	CHANNEL 11 (-)
18	ANALOG GND
19	CHANNEL 16 (+)
20	CHANNEL 10 (-)
21	N/C
22	ANALOG GND
23	CHANNEL 13 (+)
24	CHANNEL 14 (+)
25	CHANNEL 12 (+)

N/C = No connection

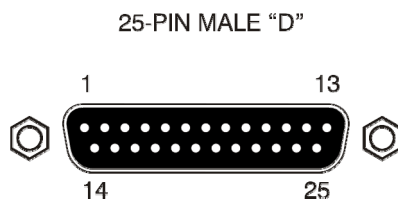

- Note: RS20i Analog channels are designed to be balanced, not single ended, for highest sound quality. If wiring single ended, wire only to (+) and ground. The (-) side of the channels should not be connected. Do not short the (-) sides of the channels to ground, which will degrade sound quality and cause the RS20i to overheat.



ANALOG AUDIO IN – DB25F	
Pin	Description
1	CHANNEL 1 (-)
2	CHANNEL 6 (+)
3	CHANNEL 6 (-)
4	CHANNEL 5 (-)
5	CHANNEL 8 (-)
6	CHANNEL 2 (-)
7	CHANNEL 7 (-)
8	CHANNEL 3 (-)
9	GND
10	GND
11	GND
12	CHANNEL 4 (-)
13	GND
14	CHANNEL 1 (+)
15	CHANNEL 5 (+)
16	CHANNEL 8 (+)
17	CHANNEL 2 (+)
18	CHANNEL 7 (+)
19	GND
20	CHANNEL 3 (+)
21	N/C
22	GND
23	GND
24	CHANNEL 4 (+)
25	N/C

N/C = No connection

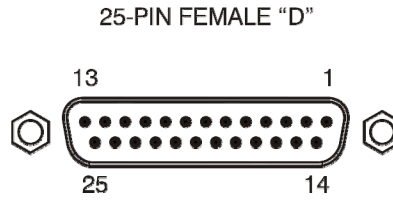

- Note: RS20i Analog in and out channels are designed to be balanced, not single ended, for highest sound quality. If wiring single ended, wire only to (+) and ground. The (-) side of the channels should not be connected. Do not short the (-) sides of the channels to ground, which will degrade sound quality and cause the RS20i to overheat.

## Appendix B: Interface Wiring Diagrams

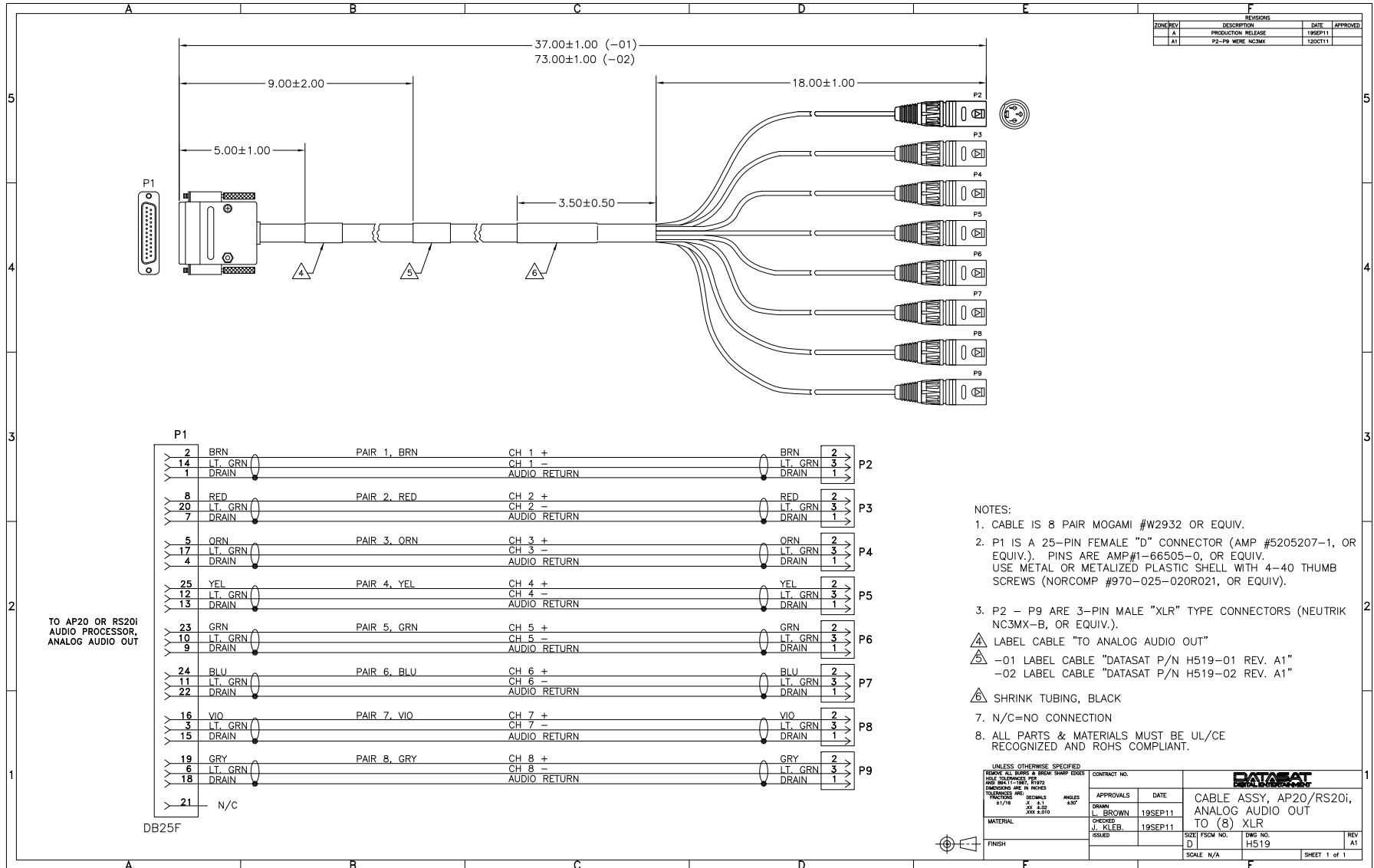

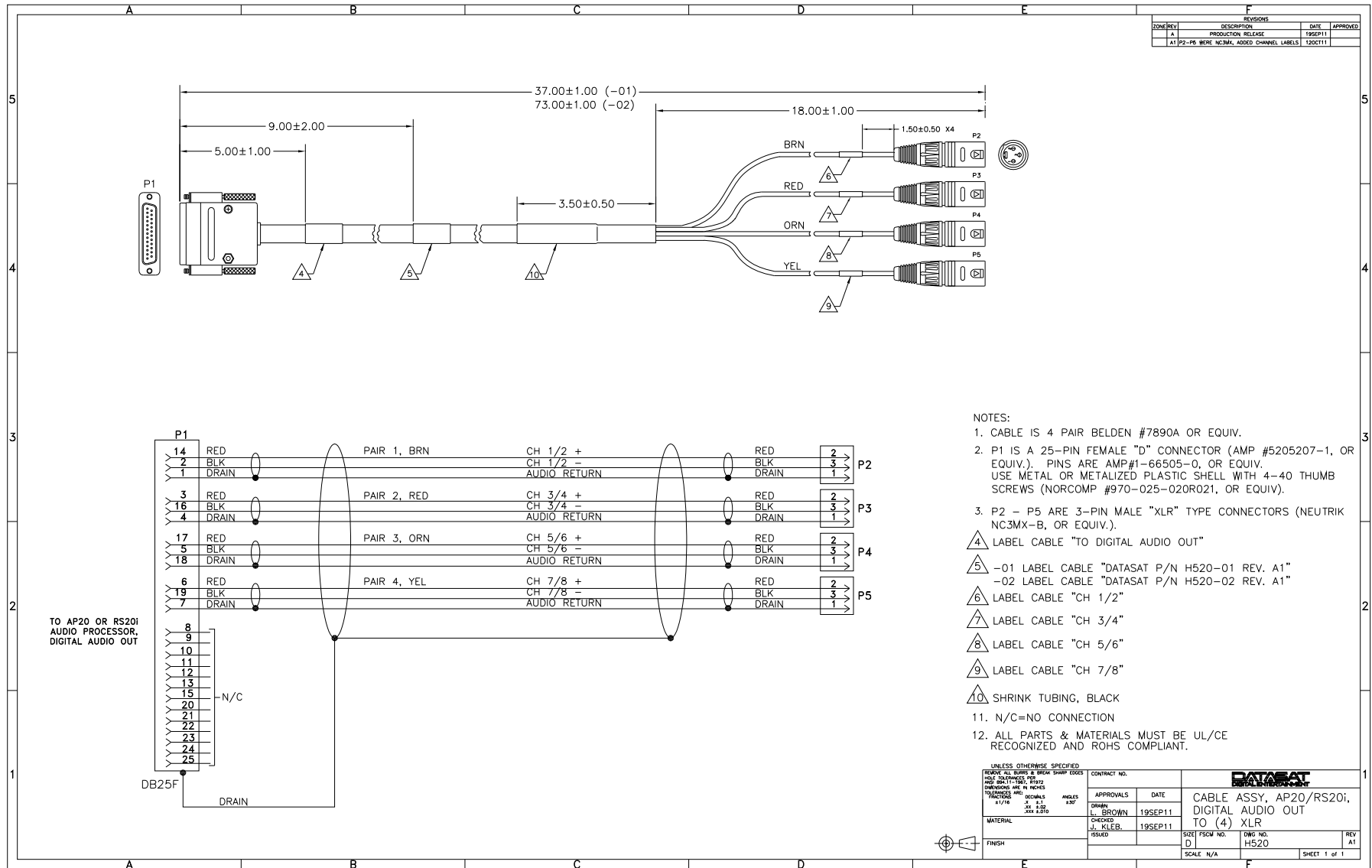

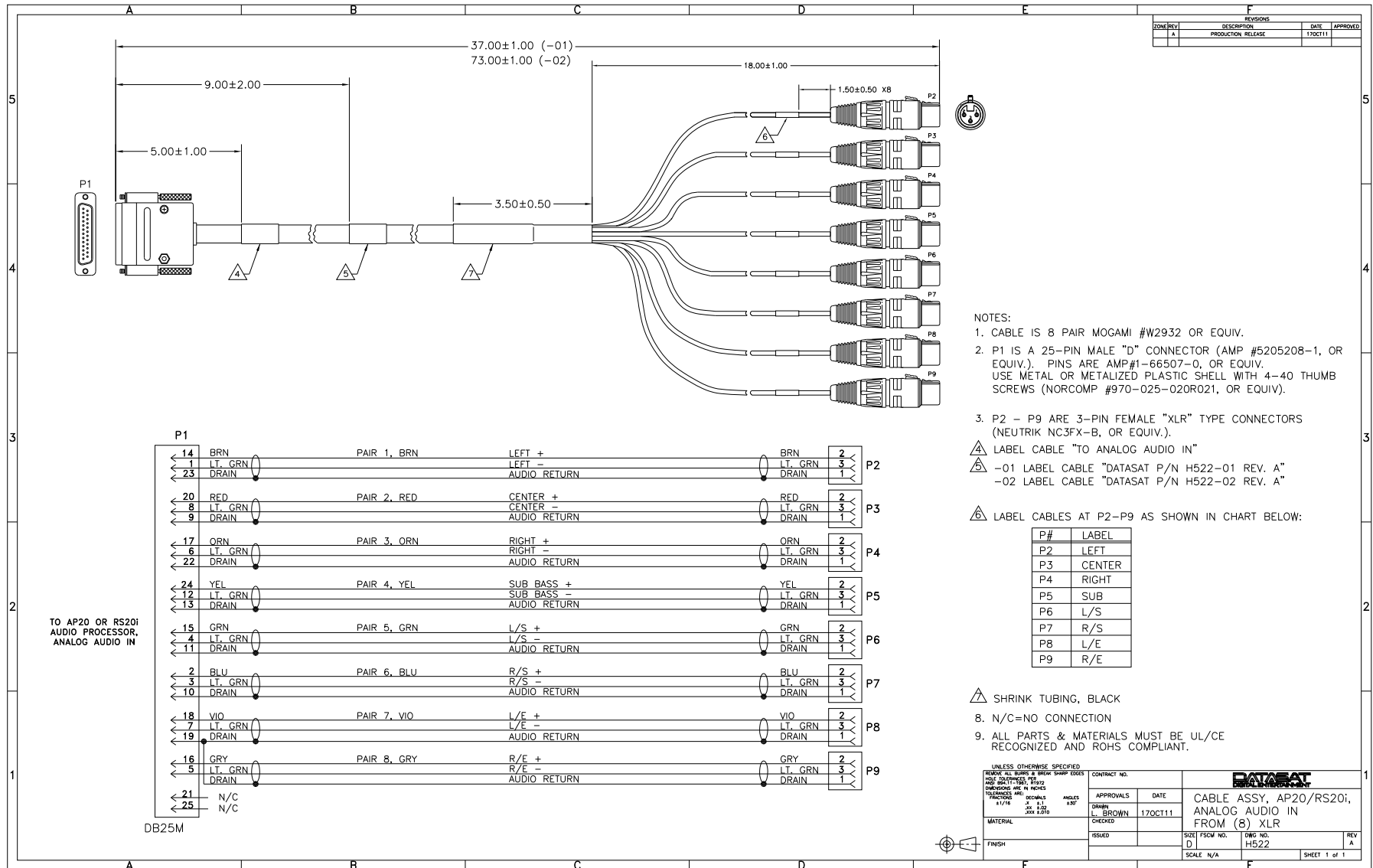

- NOTES:
- CABLE IS 8 PAIR MOGAMI #W2932 OR EQUIV.
  - P1 IS A 25-PIN MALE "D" CONNECTOR (AMP #5205208-1, OR EQUIV.). PINS ARE AMP#1-66507-0, OR EQUIV. USE METAL OR METALIZED PLASTIC SHELL WITH 4-40 THUMB SCREWS (NORCOMP #970-025-020R021, OR EQUIV).
  - P2 - P9 ARE 3-PIN FEMALE "XLR" TYPE CONNECTORS (NEUTRIK NC3FX-B, OR EQUIV.).

- ⚠ LABEL CABLE "TO ANALOG AUDIO IN"
- ⚠ -01 LABEL CABLE "DATASAT P/N H522-01 REV. A"
- ⚠ -02 LABEL CABLE "DATASAT P/N H522-02 REV. A"

⚠ LABEL CABLES AT P2-P9 AS SHOWN IN CHART BELOW:

P#	LABEL
P2	LEFT
P3	CENTER
P4	RIGHT
P5	SUB
P6	L/S
P7	R/S
P8	L/E
P9	R/E

- ⚠ SHRINK TUBING, BLACK
- N/C=NO CONNECTION
- ALL PARTS & MATERIALS MUST BE UL/CE RECOGNIZED AND ROHS COMPLIANT.

UNLESS OTHERWISE SPECIFIED		CONTRACT NO.		DRAFTER	
DATE	17OCT11	APPROVALS	DATE	SCALE	N/A
DRAWN	L. BROWN	CHECKED		ISSUED	
MATERIAL		FINISH		SIZE	FROM NO. H522
				DWG NO.	H522
				REV	A
				SHEET	1 of 1

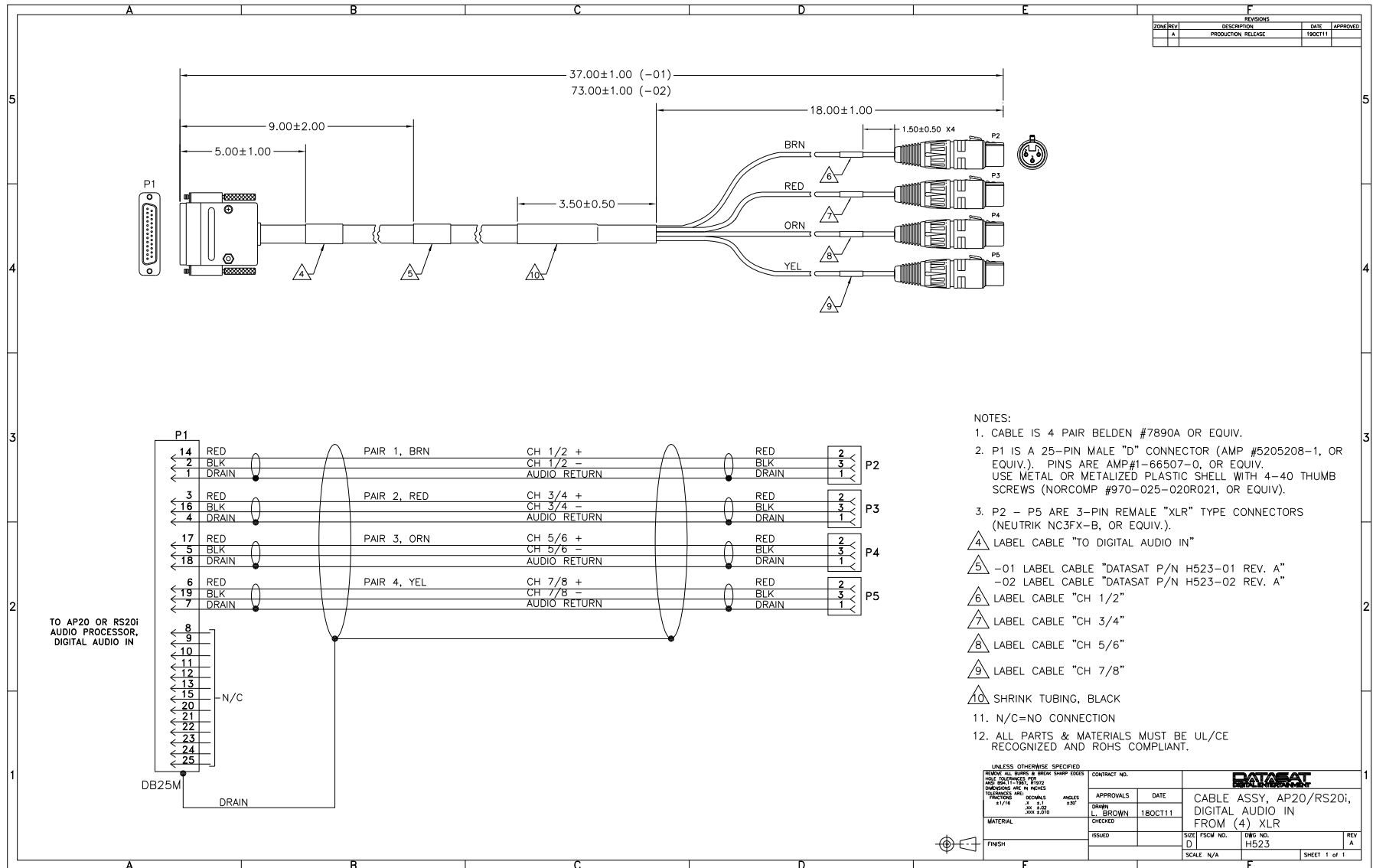

NOTES:

- CABLE IS 4 PAIR BELDEN #7890A OR EQUIV.
  - P1 IS A 25-PIN MALE "D" CONNECTOR (AMP #5205208-1, OR EQUIV.). PINS ARE AMP#1-66507-0, OR EQUIV. USE METAL OR METALIZED PLASTIC SHELL WITH 4-40 THUMB SCREWS (NORCOMP #970-025-020R021, OR EQUIV).
  - P2 - P5 ARE 3-PIN REMALE "XLR" TYPE CONNECTORS (NEUTRIK NC3FX-B, OR EQUIV.).
- △ LABEL CABLE "TO DIGITAL AUDIO IN"
- △-01 LABEL CABLE "DATASAT P/N H523-01 REV. A"
- △-02 LABEL CABLE "DATASAT P/N H523-02 REV. A"
- △ LABEL CABLE "CH 1/2"
- △ LABEL CABLE "CH 3/4"
- △ LABEL CABLE "CH 5/6"
- △ LABEL CABLE "CH 7/8"
- △ SHRINK TUBING, BLACK
11. N/C=NO CONNECTION
12. ALL PARTS & MATERIALS MUST BE UL/CE RECOGNIZED AND ROHS COMPLIANT.

UNLESS OTHERWISE SPECIFIED		CONTRACT NO.		DRAWN	
REVISION NO.	DATE	APPROVALS	DATE	DATE	DATE
1		L. BROWN	18OCT11		
MATERIAL	CHECKED	ISSUED	SCALE	SIZE	REV
		D	N/A	D	A

**DATASAT**

CABLE ASSY. AP20/RS20i;  
DIGITAL AUDIO IN  
FROM (4) XLR

ONE NO. H523

SHEET 1 of 1

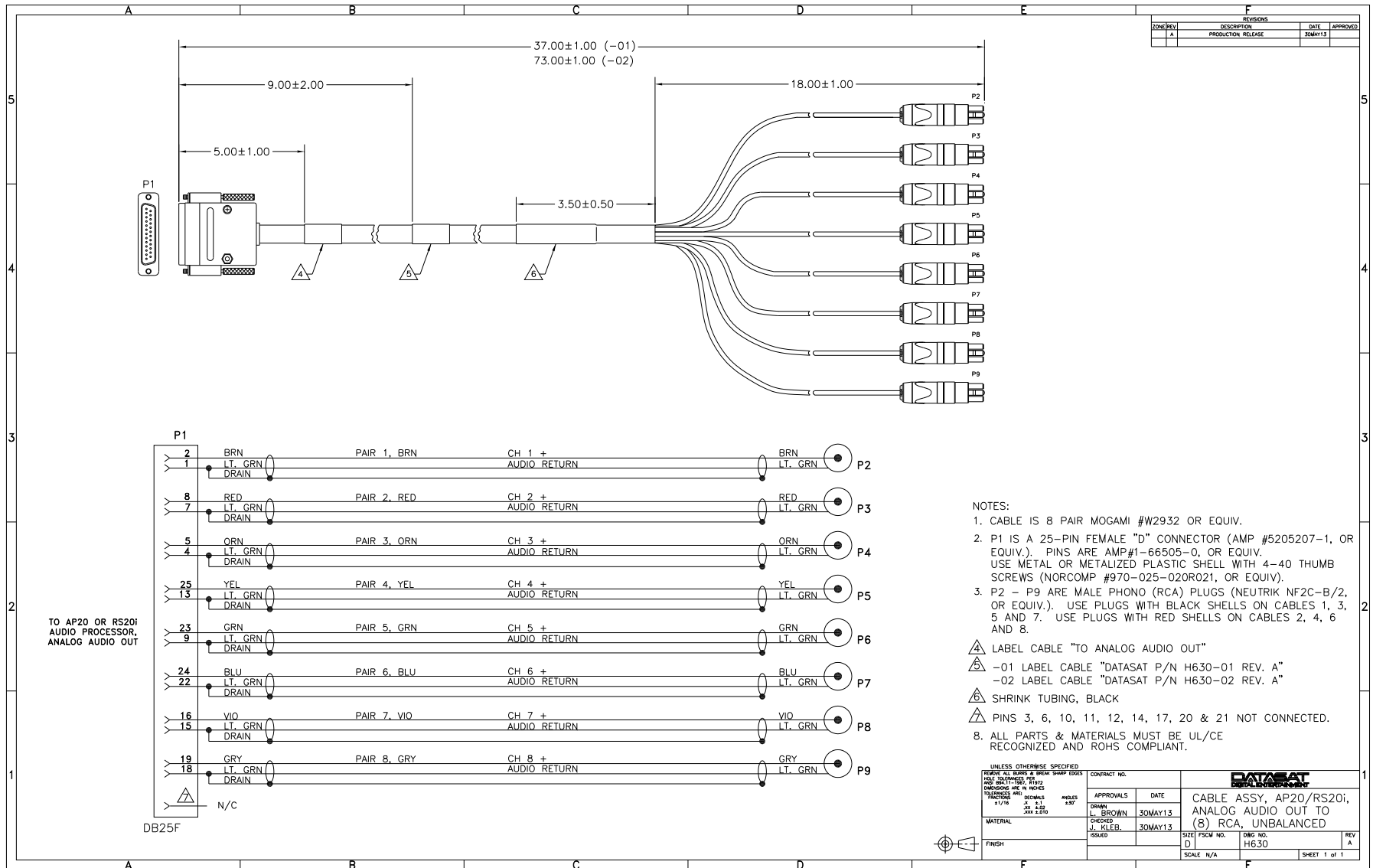

## Appendix C: RS20i Product Specifications

### Digital Audio Decoders

#### Auro (option)

- Auro-3D<sup>®</sup> Decoding Engine
- Auro-3D<sup>®</sup> Upmix Engine

#### Dolby

- Dolby<sup>®</sup> Digital Plus
- Dolby<sup>®</sup> ProLogic<sup>®</sup> IIx and IIz
- Dolby<sup>®</sup> TrueHD

#### DTS

- DTS-HD Master Audio™
- DTS Neo:X™

### Signal Inputs

#### HDMI Audio & Video Inputs

- Audio Channels: Up to 8 (LPCM, DTS-HD Master Audio & Dolby AC3)
- Connectors: 5 HDMI connectors (4 switched as inputs and 1 as output)
- HDMI V1.4a compliant digital audio with video pass-thru

#### Digital Audio Inputs

- Channels: 16
- Connectors: Two DB25 Female (Ch1-8 and Ch9-16)
- Digital Format: AES/EBU
- Sample Rates: 44.1kHz, 48kHz, 96kHz and 192kHz

#### Other Digital Audio Inputs

- Connectors: Two TOSLINK (optical S/PDIF) and 1 coaxial (S/PDIF)

#### Analog Audio Inputs

- Channels: 8 balanced, can be connected unbalanced
- Connector: DB25 (Female)
- Impedance: 10k ohms
- Reference level: 300mV RMS

#### Other Analog Audio Inputs

- Channels: 2 stereo single ended input pairs
- Connectors: 4 RCA jacks
- Impedance: 10k ohms
- Sensitivity Adjustable: -16dBv to -4dBv

#### Microphone Input

- Single channel -68dBv to -8dBv input with switchable +48V phantom power
- Connector: XLR female

## Signal Outputs

### Digital Audio Outputs

- Channels: 16, fully routable as to input
- Connectors: Two DB25 Male (Ch1-8 and Ch9-16)
- Digital Format: AES/EBU
- Sample Rates: 48kHz, 96kHz and 192kHz

### Analog Audio Outputs

- Channels: 16 (fully routable as to input), common mapping with Digital Outputs
- Balanced (can be connected unbalanced or single ended)
- Connectors: Two DB25 Male (Ch1-8 and Ch9-16)
- Level: 300mV with Volume at -15.0, +26dBu max (balanced)
- Connector: 1 single ended RCA output, channel-selectable to drive an external monitor. Adjustable Levels, to 300mV RMS
- Connector: 1 single ended RCA output, summed output for the hearing impaired. - Fixed Level Out, 300mV RMS

## Audio EQ

### Dirac Live® Room Optimization

- 16-Channel Dirac Live® room optimization
- Dirac Live® Installer kit sold separately

### 3rd Octave EQ

- 16 channels - 31 user-adjustable bandpass filters
- Gain +/-6dB adjustable in 0.5dB steps
- Frequencies range from 20Hz to 20kHz.

### Parametric

- 16 channels with 3 user-adjustable parametric filters for shaping Subwoofer response.
- Adjustable from 20 to 200Hz, gain +/-6dB in 0.1dB steps
- Q range from 0.7 to 5.

### Hi/Low/Bandpass Active Crossovers

- Adjustable from 20Hz to 20kHz. Adjustable slope and filter types: 6, 12, 18, 24, and 48 dB/octave Butterworth; 12, 24, and 48 dB/octave Linkwitz-Riley; and 6, 12, 18, 24, and 48 dB/octave Bessel.

### Bass/Treble tone control

- Adjustable +/-6dB per channel
- Corner frequency for bass adjustable from 50Hz to 300Hz
- Corner frequency for treble adjustable from 1.5kHz to 12.0kHz

### Bass Management

- Full or adjustable high pass settings for screen and surround speakers
- Adjustable high pass filter for sub woofers
- Support for 0 to 4 sub woofers
- Optional phantom center or phantom surround speakers

## Audio Delays



### Individual Channel Delays

- 0 - 1000ms

### Global Delay

- 0 –1000ms

*Note: Total delay per channel not to exceed 1000ms*

### Automation Inputs/Outputs

- 16 bi-directional GPIO's, optically isolated, DB25 connector
- 4 programmable 12V output triggers, 3.5mm mono jack
- External +5v@140mA

### Management

#### Remote Control

- RS232 DB9
- 10/100Mbps Ethernet
- Can be controlled by smart phone, iPad, Android based devices via iRule or VNC
- Crestron Integrated Device

#### Setup/Operation Profiles

- Configurable for up to 20 user defined named input selections. Input selections include processing options along with a selected named set for EQ and output presets.
- Configurable for up to 20 user defined named EQ sets which include definitions for Dirac optimization, third octave EQ, parametric EQ, bass and treble controls.
- Configurable for up to 20 user defined output presets which include output channel names, output routing, crossover high/low pass filters.
- User defined input selections controllable by Touchscreen, GPIO, or Ethernet
- Export/Load of user configurations via USB

### Power Requirements

- 105-130 VAC or 215-260 VAC, 50-60Hz. Input voltage range manually switched at the rear panel by rotating the fuse holder.
- 94w power consumption

### Hardware Dimensions

- Imperial - 5.60”(H) x 17.40”(W) x 17.63”(D). Height with feet removed 5.25”.
- Metric - 14.22 cm(H) x 44.20 cm(W) x 44.78 cm(D). Height with feet removed 13.34 cm.
- Shipping Weight (with packaging and accessories) 36 lbs (16.33 kg)
- RS20i unit weight 26.5lbs (12.02 kg)
- 3U 19” rackmount with optional ears
- RS20i depth behind optional rack ears 16.86” (42.82 cm)

**Regulatory Compliance**

- UL CB Scheme
- FCC Part 15, subpart B Class B
- CE
- RoHS compliant

**E&OE**

All product specifications subject to change without notice. All trademarks are properties of their respective owners.

## Appendix D: Speaker Configurations

Datasat Digital Entertainment is a pioneer in surround sound, with roots in the introduction of 5.1 digital surround in cinemas and on LaserDisc in the early 1990s. Today, Datasat's innovative range of home theatre processors expands upon those possibilities, supporting up to 13.1 channels of immersive sound. This document is a guide to speaker placement for today's most popular sound formats, from 5.1 to Auro-3D 13.1.



### 5.1

The most common configuration for home theatre is 5.1, utilizing Left, Center and Right front channels, stereo surrounds and a Low Frequency Effects (LFE) channel (commonly routed to one or more subwoofers). Most television broadcasts, Blu Rays, DVDs and streaming content are mixed and mastered for 5.1.

The surround speakers should be positioned to each side (or to the side and slightly behind) of the listening position, between 90 degrees and 110 degrees. The ideal height for the surround speakers is for the tweeters to be at, or just above, ear level at the listening position.



### 7.1

7.1 (available on many Blu Ray discs as DTS-HD Master Audio, Dolby TrueHD or uncompressed LPCM soundtracks) adds a pair of discrete back surround channels, for a total of 4 surrounds: Left Surround, Left Back Surround, Right Back Surround and Right Surround.

For a 7.1 setup, the Left Surround and Right Surround speakers should be directly to the sides of the listening position, on the 90 degree axis. The Left Back and Right Back speakers should be behind the listening position, with 60 degrees of separation between each surround speaker.



### 9.1

Contemporary upmix algorithms such as DTS Neo:X and Dolby ProLogic IIz add front height channels, located directly above the Left and Right speakers. Their ideal height is at 30 degrees above the listening position.



### 11.1

DTS Neo:X also supports the addition of Left Wide and Right Wide speakers, for a total of 11.1 channels. The wide speakers should be at the same height as the 7.1 base configuration, 60 degrees wide of the center channel.

#### **A note on subwoofer placement:**

The use of subwoofers for home theatre is highly recommended, both to accurately reproduce the LFE channel and also to bass manage the other channels in the event that some or all of the speakers are not full-range. The number and placement of subwoofers can greatly affect bass response and even distribution of bass across listening positions. Every home theatre has different requirements, but Datasat recommends as a general guideline the use of 2 or even 4 subwoofers to provide accurate, even bass response.

## Auro-3D

Auro-3D is a new sound format, which adds both height and top layers of audio to create a fully immersive surround sound experience. Auro-3D incorporates both a decoder, to play back discrete 3D sound mixes (up to 13.1 channels) in their native format and an upmixer, which can create an Auro-3D soundtrack from any source.



### Auro 9.1

The minimum configuration for Auro-3D is Auro 9.1, which starts with a base 5.1 layer and adds height speakers corresponding to the Left, Right, Left Surround and Right Surround channels. The height speakers should be placed directly above their corresponding lower layer speakers. The ideal height placement is 30 degrees above horizontal from the listening position. The height speakers may be angled down slightly, but not so much that the speakers are pointed at the listening position.

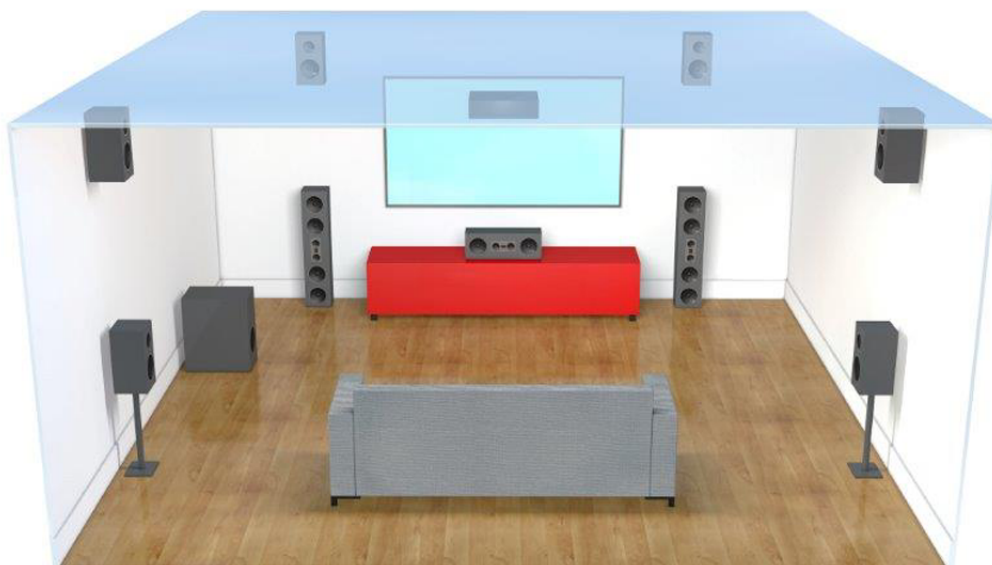

### Auro 10.1

Auro 10.1 adds a recommended overhead speaker, directly above the listening position.



### Auro 11.1

For large rooms, such as those with an acoustically transparent screen, Auro 11.1 completes the height layer by adding a height speaker corresponding to the Center channel.



### Auro 13.1

The full configuration for Auro-3D is 13.1, which adds to the 11.1 configuration the Left Back and Right Back speakers used in 7.1 configurations. For a very large room, you may add Left Back Height and Right Back Height speakers, which are ganged with the Left Surround Height and Right Surround Height speakers to create an enveloping sound field for the height layer. Although the Auro format uses a mono overhead channel, you may also for large rooms wish to use more than one overhead speaker to provide even coverage of the listening position from the top layer.

## Appendix E. Remote Command API

### Introduction

This document describes the serial and network control commands for the Datasat RS20i Audio Processor. The RS20i supports a command set for remote control and automation. These commands can be transmitted via either the Ethernet or the serial interface.

This document is intended to be used by any system integrator who needs to control the RS20i remotely. Example of an application where these commands could be used may be an automation unit, a remote control unit, or a remote software interface.

It assumes that the reader is familiar with standard serial and network TCP/IP concepts.

### Serial Control

The remote serial control device must be connected to the RS232 "Control" connector on the back of the RS20i. To configure the serial port on the RS20i, go to the menu System -> Automation -> Serial. Select the desired baud rate, and data bits should be 8. Also set **Serial Command Mode** to **RS20i**.

For test purposes you may connect to the RS20i using PuTTY or any similar serial communications program. Connection from a standard PC to the RS20i is a straight-through cable.

Once the serial connection is made and setup the user can execute any of the commands listed within this document.

### Ethernet connection to RS20i

The RJ45 connector labeled Ethernet on the back of the RS20i can be connected to a network switch or router. Once the network parameters are properly set the IP address for the RS20i can be found in the Network screen in the IP Address box.

The RS20i could also be connected directly to another network device using crossover cable, or a straight cable if the device supports auto-MDIX.

The client initiates the communication session with the RS20i IP address at TCP port 14500. Once connected the client may send commands as described in this document to set or read the RS20i configuration. The configuration changes happen as soon as they are received. For example, you should see the volume change immediately after receiving a command to set the volume.

For test purposes you may use PuTTY or any similar communications program to make a TCP/IP connection to the RS20i.

### Using PuTTY

Open PuTTY in the configuration Session and set the following:

- Host Name: (enter the RS20i IP address)
- Port: 14500
- Configuration type: Raw.
- Select the Open button.

Once the network connection is made the user may type in commands listed within this document and read the response.



## Password Protection

The RS20i may be protected from unauthorized access by setting a password under the **System > Access Control** screen. There are two levels of password protection in the RS20i, labeled as **NetCmd Password** and **Setup Password** in the system access screen on the RS20i.

### NetCmd Password

The **NetCmd Password** is used to prevent unauthorized access to the RS20i through a network connection. The **NetCmd Password** does not prevent access through the serial command.

### Setup Password

The Setup Password prevents unauthorized access to any RS20i setup commands through the RS20i local front panel or remotely through serial or Ethernet connections. This does not affect the operator level commands that are used in this document.

### Authentication Command

The AUTH command must be sent to the RS20i before sending a password protected command. If this is not done, then the command results in no action and the RS20i returns the string "SECERR". Sending the correct password enables all network commands for the password level for as long as the network connection is maintained.

Not all network commands require a password. Inquiry commands such as SYSTEM and IDENTIFY will operate without a password.

## Command Format

The general command format for all configuration commands is listed below:

**@COMMAND [arg1] [arg2]<CR>**

Each **COMMAND** and its arguments (**arg1**, **arg2**) are defined in this document. Whether or not **arg1** and/or **arg2** are used depends on the command. Square brackets **[]** around the argument in this document indicate that the argument is optional.

The command is terminated by a **<CR>**. The response returns ASCII text and is also terminated by **<CR>** character at the end. The **<CR>** represents an ASCII character with the value **0x0D**. How to enter this character in the command is entirely dependant on the remote program or interface used. On a terminal interface, it is added by pressing ENTER on the keyboard. In some GUI interfaces it is represented by "**r**", and for XML it may be **&#10**.

**Important:** If you are having problems with executing a simple command to the RS20i, check that the command string starts with '@' and properly sends the carriage return at the end.

Some commands are characterized as "Read" and are used only to read status or information from the RS20i. Commands that are "Read/Write" can be used to set the specific configuration item, or just read it.

For "Read/Write" commands the last argument is the value to write to the configuration. Omit the final argument in order to read the configuration item without changing it.

## Input Selection Commands

### 1. Input Selection

<b>Command:</b> @INPUT<space> <i>[input]</i> <CR>	<b>Operation</b>
<b>Response:</b> INPUT<space> <i>input</i> <CR>	<b>Read/Write</b>

This is used to select a new input, or view the current input.

#### Parameters

***input*** Identifies the desired or selected input name. For the set command to be successful, the name must match exactly the input name on RS20i.  
 Note: Spaces may be used within the name.  
 See the command **INPUTNAMES** to extract a list of valid input names in the current RS20i configuration.

#### Example

Set the Input to Oppo 95

**Send:** @INPUT Oppo 95<cr>

**Receive:** INPUT Oppo 95<cr>

### 2. EQ Selection

<b>Command:</b> @EQSET<space> <i>[eq]</i> <CR>	<b>Operation</b>
<b>Response:</b> EQSET <space> <i>eq</i> <CR>	<b>Read/Write</b>

This is used to select a new EQ set, or view the current EQ.

#### Parameters

***eq*** This is the EQ name which must match exactly the EQ name on RS20i.  
 Note: Spaces may be used within the name.  
 See the command **EQNAMES** to extract a list of EQ names in the current RS20i configuration.

#### Example

Set the EQ

**Send:** @EQSET eq2<cr>

**Receive:** EQSET eq2<cr>

## Control Commands

### 3. Standby Power

<b>Command:</b> @POWER<space>[mode]<CR>	<b>Operation</b>
<b>Response:</b> POWER<space>mode<CR>	<b>Read/Write</b>

This is used to control the power mode.

Note: On a network TCP/IP connection, the network connection is closed / reset during the power on process. A reconnection should be performed after power on.

#### Parameters

<i>Mode</i>	<i>Selection</i>
<b>0</b>	Power off, or sleep mode
<b>1</b>	Operating mode. Requires 15 seconds for unit to be operational

#### Example

Set unit to operating mode.

**Send:** @POWER 1<cr>

**Receive:** POWER 1<cr>

### 4. Screensaver On/Off

<b>Command:</b> @SCR<space>[Cmd]<CR>	<b>Operation</b>
<b>Response:</b> OK<CR>	<b>Write</b>

This is used to display the screen if the screensaver is active, or to activate the screensaver. This command works only when the screensaver mode is enabled in the system setup.

#### Parameters

<i>Cmd</i>	<i>Selection</i>
<b>ON</b>	Deactivate the screensaver
<b>OFF</b>	Display the screensaver

#### Example

Activate the screensaver:

**Send:** @SCR OFF<cr>

**Receive:** OK<cr>

## Automation

### 5. Execute an RS20i Macro

<b>Command:</b> @RUNMACRO<space> <i>[macro]</i> <CR>	<b>Operation</b>
<b>Response:</b> <i>OK</i> or <i>ERR no macro</i> <CR>	<b>Write</b>

This is used to execute a user defined automation macro in the RS20i. User defined macros must be created in the RS20i setup menus, or copied through the configuration file. See the command MACRONAMES to extract a list of available macros in the current RS20i configuration.

#### Parameters

***[macro]*** This is the macro name to execute. The name must match exactly the macro name on the RS20i.  
Note: Spaces may be included within the macro name.

***OK*** Response after macro is found and executed.

***ERR no macro*** Response if macro does not exist on the RS20i.

#### Example

Run Macro named Auto1

**Send:** @RUNMACRO Auto1<cr>

**Receive:** OK<cr>

### 6. Output a pulse

<b>Command:</b> @PULSE<space> <i>[output]</i> <CR>	<b>Operation</b>
<b>Response:</b> <i>OK</i> <CR>	<b>Write</b>

Activate a pulse in GPIO1-21. The pulse has a fixed length of 250ms.

#### Parameters

***[output]*** Defines the desired GPIO number for the pulse. Valid numbers are from 1 to 21.

#### Example

Send a pulse on GPIO-3

**Send:** @PULSE 3<cr>

**Receive:** OK<cr>

## Volume and Mute Commands

### 7. Master Volume Level

<b>Command:</b> @VOLUME<space>[+]/-[Value]<CR>	<b>Operation</b>
<b>Response:</b> VOLUME<space>Level<CR>	<b>Read/Write</b>

This is used to set or read the volume level.

#### Parameters

<b>[+]</b>	Add [Value] to current volume.
<b>[-]</b>	Subtract [Value] from current volume.
<b>[Value]</b>	Value to set the volume in negative tenths dB or, if +/- is used, it is the value to increment or subtract from the current volume. The value should be in increments of 5, or 0.5dB steps. Omit this argument to only read the volume.

#### Returns

<b>[Level]</b>	Current volume level represented using the range of 0 (-0dB) to 700 (-70.0 dB).
----------------	---

#### Example

Set the volume to -35dB

**Send:** @VOLUME 350<cr>

**Receive:** VOLUME 350<cr>

Increase volume by 0.5dB

**Send:** @VOLUME +5<cr>

**Receive:** VOLUME 345<cr>

### 8. Master Volume Mute

<b>Command:</b> @MUTED<space>[value]<CR>	<b>Operation</b>
<b>Response:</b> MUTED<space>value<CR>	<b>Read/Write</b>

Mute or Unmute the RS20i output.

#### Parameters

<i>value</i>	<i>Selection</i>
<b>0</b>	Unmute
<b>1</b>	Mute
<b>+</b>	Toggle Mute State

#### Example

Mute

**Send:** @MUTED 1<cr>

**Receive:** MUTED 1<cr>

**Monitor Level**

<b>Command:</b> @MONITORLEVEL<space>[/level]<CR>	<b>Operation</b>
<b>Response:</b> MONITORLEVEL<space>level<CR>	<b>Read/Write</b>

Set or read the RS20i monitor level.

**Parameters**

*level* Monitor level from 0 (minimum) to 100 (maximum).

**Example**

**MONITORLEVEL**

**Send:** @MONITORLEVEL 70<cr>

**Receive:** MONITORLEVEL 70<cr>

**9. Monitor Mute**

<b>Command:</b> @MONITORMUTE<space>[value]<CR>	<b>Operation</b>
<b>Response:</b> MONITORMUTE<space>value<CR>	<b>Read/Write</b>

Mute or unmute the RS20i monitor, or read the current setting.

**Parameters**

<i>value</i>	<i>Selection</i>
<b>0</b>	Unmute
<b>1</b>	Mute

**Example**

Mute the monitor.

**Send:** @MONITORMUTE 1<cr>

**Receive:** MONITORMUTE 1<cr>

## Audio Setup

### 10. Channel Noise Sequencer

<b>Command:</b> @NOISESEQ<space>[value]<CR>	<b>Operation</b>
<b>Response:</b> NOISESEQ value<CR>	<b>Read/Write</b>

Enable an internally generated pink noise that is sequenced through RS20i channels. The exact channel sequence is dependant on the speaker configuration. This sequence for each speaker configuration is shown in the table below. The LFE and additional sub woofers are not included in the noise sequence.

**NOTE! Auro-3D configurations are only available if the RS20i has the Auro-3D option installed**

#### Parameters

<i>value</i>	<i>Selection</i>
<b>0</b>	Turn off pink noise.
<b>1</b>	Automatically sequence pink noise through each channel.
<b>2</b>	Manual mode: Use to stop pink noise on current speaker.
<b>3</b>	Channel Step. Advance to the next channel in the sequence and return to manual mode (value will be <b>2</b> when read from the command).

**Table 1. Non-Auro Configurations**

Speaker Configuration	Channel Sequence										
2.0	L		R								
2.1	L		R								
3.1	L	C	R								
4.1	L		R			RS			LS		
5.1	L	C	R			RS			LS		
7.1h	L	C	R		HR	RS			LS		
7.1w	L	C	R	RW		RS			LS		LW
9.1hw	L	C	R	RW	HR	RS			LS	HL	LW
7.1	L	C	R			Rs	Rb	Lb	Ls	HL	
9.1h	L	C	R		HR	Rs	Rb	Lb	Ls	HL	
9.1w	L	C	R	RW		Rs	Rb	Lb	Ls		LW
11.1hw	L	C	R	RW	HR	Rs	Rb	Lb	Ls	HL	LW

**Table 2. Auro Configurations**

Speaker Configuration	Channel Sequence												
	L	C	R	Rs			Ls	HL		HR	HRs	HLs	
Auro 9.1	L	C	R	Rs			Ls	HL		HR	HRs	HLs	
Auro 10.1	L	C	R	Rs			Ls	HL		HR	HRs	HLs	T
Auro 11.1	L	C	R	Rs			Ls	HL	HC	HR	HRs	HLs	T
Auro 11.1 (7+4)	L	C	R	Rs			Ls	HL		HR	HRs	HLs	
Auro 13.1	L	C	R	Rs	Rb	Lb	Ls	HL	HC	HR	HRs	HLs	T
Auro 13.1 with phantom HC	L	C	R	Rs	Rb	Lb	Ls	HL		HR	HRs	HLs	T

**Example**

Start automatic pink noise sequence.

**Send:** @NOISESEQ 1<cr>

**Receive:** NOISESEQ 1<cr>

Turn off pink noise.

**Send:** @NOISESEQ 0<cr>

**Receive:** NOISESEQ 0<cr>

**Audio Decoder Configuration**

**11. Post Processing Mode**

Select post processing function between None, DTS NeoX, Dolby Pro Logic II or IIx, Dolby Pro Logic IIz, or Auro-3D.

The option for Pro Logic IIz is only valid for speaker configurations that include front left/right high speakers. If Pro Logic IIz is selected for a speaker configuration without these speakers, the system defaults to operating as if None were selected for the processing mode.

<b>Command:</b> @DECODERPOST [mode]<cr>	<b>Operation</b>
<b>Response:</b> DECODERPOST [mode]<CR>	<b>Read/Write</b>

**Parameters**

[mode]	Selection	Valid Speaker Configurations
0	Off/None	Any
3	DTS Neo:X	All, except 2.0 or 2.1
4	Dolby PLII, or Dolby PLIIx	Not Available for 2.0 or 2.1 PLIIx for all configuration with LB/RB PLII for all other configurations
5	Dolby PLIIz	Must include High Left / High Right
6	Auro-3D	Auro 9.1, Auro 10.1, Auro 11.1 or Auro 13.1, 2.0, 2.1, 5.1, 7.1



**Notes:**

The mode will not change when the selected mode is not valid for the current speaker configuration.

**Sub Configurations**

**DTS Neo:X** See the command **NEOXMODE** for details on configuration item available only with DTS Neo:X.

**Dolby PLIIX** See the command **DPL2MODE** for details on Pro Logic IIx configuration items.

**Dolby PLIIZ** See the command **DPL2HEGAIN** for details on and additional Pro Logic IIz configuration item.

**Example**

Enable DTS Neo:X.

**Send:** @DECODERPOST 3<cr>

**Receive:** DECODERPOST 3<cr>

**12. Neo:X Mode**

Select Neo:X mode to Cinema, Music or Game. The Neo:X mode selection is in affect only when the Post Processing Mode (**DECODERPOST**) is set for Neo:X.

<b>Command:</b> @NEOXMODE [value]<cr>	<b>Operation</b>
<b>Response:</b> NEOXMODE [value]<CR>	<b>Read/Write</b>

**Parameters**

[value]	Selection
0	Cinema
1	Music
2	Game

**13. Generate Subwoofer with Neo:X**

Generate a subwoofer (LFE) channel when using Neo:X with a 2-channel input source.

<b>Command:</b> @NEOXLFE [value]<cr>	<b>Operation</b>
<b>Response:</b> NEOXLFE [value]<CR>	<b>Read/Write</b>

**Parameters**

[value]	Selection
0	Disable
1	Enable

#### 14. Pro Logic II/IIx Mode

Selects Pro Logic II or Pro Logic IIx mode to Pro Logic, Music, Game or Dolby Digital EX. The Pro Logic II/IIx mode selection is in affect only when the Post Processing Mode (**DECODERPOST**) is set for Pro Logic II or Pro Logic IIx.

<b>Command:</b> @DPL2MODE [value]<cr>	<b>Operation</b>
<b>Response:</b> DPL2MODE [value]<CR>	<b>Read/Write</b>

#### Parameters

[value]	Selection
<b>0</b>	Pro Logic (1)
<b>2</b>	Music
<b>3</b>	Movie
<b>4</b>	Dolby Digital EX (2)

#### Notes:

1. Pro Logic can only be selected with Pro Logic II (speaker configuration without LB/RB).
2. Pro Logic EX can only be selected with Pro Logic IIx (speaker configuration with LB/RB).

Three additional controls are available only for use with Pro Logic IIx Music mode (**DPL2MODE 1**). Those are Dimension, Center Width, and Panorama. See commands **DPL2DIM**, **DPL2CW**, and **DPL2PANO** for additional details.

#### 15. Dimension for Pro Logic IIx Music Mode

The Dimension control is used with Pro Logic IIx music mode to adjust the sound field.

<b>Command:</b> @DPL2DIM [DIM]<cr>	<b>Operation</b>
<b>Response:</b> DPL2DIM DIM<CR>	<b>Read/Write</b>

**Parameters:**

<b>DIM</b>	<b>Selection</b>	
<b>7</b>	+ 7	Sound field towards the rear
<b>6</b>	+ 6	
<b>5</b>	+ 5	↑
<b>4</b>	+ 4	
<b>3</b>	+ 3	↓
<b>2</b>	+ 2	
<b>1</b>	+ 1	Sound field towards the front
<b>0</b>	0	
<b>-1</b>	- 1	
<b>-2</b>	- 2	
<b>-3</b>	- 3	
<b>-4</b>	- 4	
<b>-5</b>	- 5	
<b>-6</b>	- 6	
<b>-7</b>	- 7	

**16. Center Width for Pro Logic IIx Music Mode**

The Center Width control works with Pro Logic IIx music.

<b>Command:</b> @DPL2CW [cw]<cr>	
<b>Response:</b> DPL2CW cw<CR>	<b>Read/Write</b>

**Parameters:**

<b>cw</b>	<b>Selection</b>	
<b>0</b>	0	(Off, no balance applied)
<b>1</b>	1	(Neutral)
<b>2</b>	2	
<b>3</b>	3	Phantom Center
<b>4</b>	4	
<b>5</b>	5	
<b>6</b>	6	
<b>7</b>	7	

**17. Panorama for Pro Logic IIx Music Mode**

Enable or Disable the Panorama setting used with Pro Logic IIx music mode.

<b>Command:</b> @DPL2PANO [pano]<cr>	
<b>Response:</b> DPL2PANO pano <CR>	<b>Read/Write</b>

**Parameters:**

<b>pano</b>	<b>Selection</b>	
<b>0</b>	0	Panorama off
<b>1</b>	1	Panorama on

### 18. Height Gain for Pro Logic IIz

This command sets or reads the height gain selection used with Pro Logic IIz.

<b>Command:</b> @DPL2HEGAIN [value]<cr>	
<b>Response:</b> DPL2HEGAIN value<CR>	<b>Read/Write</b>

Parameters:

[value]	Selection
0	Low
1	Mid
2	High

### 19. Auro-3D Strength

This command sets upmixing strength for Auro-3D

<b>Command:</b> @AUROSTRENGTH [value]<cr>	
<b>Response:</b> AUROSTRENGTH value<CR>	<b>Read/Write</b>

Parameters:

[value]	Selection
1-16	16 is the highest strength level

### 20. Auro-3D Preset

This command sets or reads the Auro-3D Preset. Selections are Small, Medium, Large, or Speech

<b>Command:</b> @AUOPRESET [value]<cr>	
<b>Response:</b> AUOPRESET value<CR>	<b>Read/Write</b>

Parameters:

[value]	Selection
0	Small
1	Medium
2	Large
3	Speech

### 21. Auro-3D Listening Mode

This command sets or reads the Auro-3D Listening Mode. Selections are Stereo, Surround, and Auro-3D

<b>Command:</b> @AUOLM [value]<cr>	
<b>Response:</b> AUOLM value<CR>	<b>Read/Write</b>

Parameters:

[value]	Selection
0	Stereo
1	Surround
2	Auro-3D (Valid only with one of the Auro speaker Configurations)

## 22. Dolby DRC Setting

Command:	@TRUEHDDRC [drc]<cr>	
Response:	TRUEHDDRC drc<CR>	Read/Write

Parameters:

drc	Selection
0	DRC Off
1	On / TrueHD-Auto
2	DRC On

## LFE Boost

### 23. DTS LFE Boost

Enable 10dB gain to the subwoofer outputs when playing DTS audio

Command:	@ DECODERDTSLFEBOOST [dtslfe]<cr>	
Response:	DECODERDTSLFEBOOST [dtslfe]<CR>	Read/Write

Parameters:

dtslfe	Selection
0	Do not apply 10dB gain for DTS
1	Apply 10dB gain for DTS

### 24. PCM LFE Boost

Enable 10dB gain to the subwoofer outputs when playing PCM audio

Command:	@ DECODERPCMLFEBOOST [pcmlfe]<cr>	
Response:	DECODERPCMLFEBOOST pcmlfe<CR>	Read/Write

Parameters:

pcmlfe	Selection
0	Do not apply 10dB gain for PCM
1	Apply 10dB gain for PCM

## 25. Dolby LFE Boost

Enable 10dB gain to the subwoofer outputs when playing Dolby Digital decoded audio

<b>Command:</b> @DECODERDDLFEBOOST <i>[ddlfe]</i> <cr>	
<b>Response:</b> DECODERDDLFEBOOST <i>ddlfe</i> <CR>	<b>Read/Write</b>

Parameters:

<i>ddlfe</i>	<b>Selection</b>
<b>0</b>	Do not apply 10dB gain for Dolby Digital
<b>1</b>	Apply 10dB gain for Dolby Digital

## Audio Decoder Stream Information

### 26. Decoder Stream

Returns a text description of the stream type currently playing

<b>Command:</b> @DECSTREAM<cr>	
<b>Response:</b> <i>[Desc]</i> <CR>	<b>Read/Write</b>

Parameters:

*[Desc]* Description of the current audio stream type being received by the decoder.

#### Example

**Send:** @DECSTREAM<cr>  
**Receive:** DTS 48k + NeoX <cr>

### 27. Decoder Channels

Returns a text description of the number of channels at the decoder output. This does not include additional channels from processing by Auro Decoder or Upmix, DTS NEO:X or Dolby PLIIx/PLIIy.

<b>Command:</b> @DECCHANS<cr>	
<b>Response:</b> <i>[n.s]</i> <CR>	<b>Read/Write</b>

The string *[n/m/.s]* appears only when the decoder is running. In that case the values *n*, *m*, and *s* are defined as follows.

*[n]* Number of front channels at the decoder output.  
*[s]* The value is 1 when there is a decoder subwoofer output. Otherwise it is 0.

#### Example

**Send:** @DECCHANS <cr>  
**Receive:** 7.1 <cr>

## Setup Information

These commands return information regarding the current setup of the RS20i in terms of what inputs and automation macros have been defined.

### 28. List Input Names

The RS20i may have up to 20 user-defined Input names. This command returns a comma delimited string with all Input names assigned in the RS20i.

<b>Command:</b> @INPUTNAMES <cr>	<b>Operation</b>
<b>Response:</b> INPUTNAMES <i>input1,[input2],[input3],...</i> <CR>	<b>Read</b>

#### Parameters

*input1-input20* Input names. There may be 1 to 20 Input names. Each name will have a comma to separate it from the next name. Spaces may be included in the Input names.

### 29. List Macro Names

The RS20i may have several user-defined macros. This command returns a comma delimited string with all macro definitions in the RS20i.

<b>Command:</b> @MACRONAMES <cr>	<b>Operation</b>
<b>Response:</b> MACRONAMES [ <i>m1],[m2],[m3],...</i> <CR>	<b>Read</b>

#### Parameters

*m1-mx* Macro names. Each name will have a comma to separate it from the next name. Spaces may be included within the macro names. This will be empty if there are no macros defined in the RS20i.

### 30. List EQ Setup Names

The RS20i may up to 20 different EQ sets stored. This command returns a comma delimited string with all EQ setup names.

<b>Command:</b> @EQNAMES<cr>	<b>Operation</b>
<b>Response:</b> EQNAMES <i>e1,[e2],[e3],...</i> <CR>	<b>Read</b>

#### Parameters

*e1-ex* EQ set names. Each name will have a comma to separate it from the next name. Spaces may be included within the macro names.

## General Commands

### 31. System Information

Returns system versions and MAC address

<b>Command:</b> @SYSTEM <cr>	<b>Operation</b>
<b>Response:</b> VER<space> <i>version</i> <LF> VERDATE<space> <i>date</i> <LF> MAC<space> <i>mac address</i> <CR>	<b>Read</b>

#### Parameters

*version* Software version number  
*date* Software date/time  
*mac address* RS20i 20 MAC address

### 32. Identify

Get system identify information. Mostly used in discovery protocol.

<b>Command:</b> @IDENTIFY<cr>	<b>Operation</b>
<b>Response:</b> AP20<space>IP, [info2],[info1],[screen]<cr>	<b>Read</b>

#### Parameters

- AP20** General identifier for Datasat audio processor product. See **MODEL** command to determine an RS20i model.
- ip** IP address (useful after network broadcast command)
- [Info2]** User entered information, if entered in the RS20i configuration.
- [Info1]** User entered information, if entered in the RS20i configuration.
- [Screen]** User defined ID string, if entered in the RS20i configuration.

### 33. Model

Determines that the Datasat Audio processor is an RS20i.

<b>Command:</b> @MODEL<cr>	<b>Operation</b>
<b>Response:</b> MODEL<space>RS20i<cr>	<b>Read</b>

#### Parameters

- RS20i** An RS20i returns this model string.

### 34. Authorization

<b>Command:</b> @AUTH<space>[Password]<cr>	<b>Operation</b>
<b>Response:</b> AUTH<space>[SETUP/OP/SECERR]<cr>	<b>Read</b>

Give a password to allow usage of restricted commands. The authorization is required for many commands if access to the RS20i has been configured with a Password. The **AUTH** must be issued before issuing any password protected commands, and is valid only for the duration of the TCP/IP connection.

Note: This application accepts only Latin alphanumeric characters.

There are two levels of password protection in the RS20i. Both levels are set in the **System > Access Control** screen on the RS20i. The top password labeled **NetCmd Password** will allow access to the RS20i for Operator level type commands. The bottom password labeled **Setup Password** allows access to setup and configuration level commands. The commands in this document only require the operator level password (if set).

The **AUTH** may be used for either the Operator or Setup level password.

#### Parameters:

- [Password]** NetCmd or Setup level password. The RS20i compares this first with setup level password and gives Setup Level authorization if it matches. Otherwise, it compares it to the NetCmd password and authorizes operator commands if it matches.
- SETUP** The RS20i returns this value when Setup Level authorization has been granted.
- OP** The RS20i returns this value when NetCmd Level authorization has been granted.



**SECERR** The RS20i returns this value if neither Setup nor Operator level authorization has been granted.

### 35. Serial Number

<b>Command:</b> @ <b>SERIALNO</b> <CR>	<b>Operation</b>
<b>Response:</b> <b>SERIALNO</b> <space> <b>SN</b> <CR>	<b>Read</b>

Reads the RS20i serial number.

#### Parameters

**SN** This value is the serial number string that has been permanently assigned to the RS20i unit.

### 36. MAC Address

<b>Command:</b> @ <b>MAC</b> <CR>	<b>Operation</b>
<b>Response:</b> <b>MAC</b> <space> <b>Mac adr</b> <CR>	<b>Read</b>

Reads the RS20i network MAC address.

#### Parameters

**Mac adr** This is the 12 digit RS20i network interface MAC address.

#### Example

**Send:** @MAC<cr>  
**Receive:** MAC 080077124578<cr>